

# EROSION PREVENTION AND SEDIMENT CONTROL PLANNING AND DESIGN MANUAL

June 2020



**EROSION PREVENTION  
AND  
SEDIMENT CONTROL**

**PLANNING AND DESIGN MANUAL**

---

---

**Developed in Partnership with:**

City of Gladstone

City of Happy Valley

City of Lake Oswego

City of Milwaukie

City of Oregon City

City of West Linn

City of Wilsonville

Clean Water Services (CWS)  
Of Washington County

Oak Lodge Water Services District

Water Environment Services (WES)  
Of Clackamas County, Oregon

**Revised  
June 2020**

## **DISCLAIMER**

The Erosion Prevention and Sediment Control Planning and Design Manual was developed for the sole purpose of providing the most updated Erosion, Prevention, Run-off, and Sediment Controls Best Management Practices (BMPs). The contents of this manual should not be interpreted as representing the policies or recommendations of the referenced agencies or organizations.

The mention of trade names, products or companies does not constitute an endorsement.

The previous revision of this manual was December 2008. Periodic updates will be made as materials, practices, and policies change within the industry and are made available.

This page intentionally left blank.

# Table of Contents

\*\*\*\*\*

## **Chapter 1: Background**

1.1	Introduction-----	1-2
1.2	Regulatory Background and Policies-----	1-2
1.3	NPDES Construction Stormwater Permits-----	1-2
1.3.1	NPDES Construction Stormwater Permit Requirements-----	1-3
1.3.2	Penalties for Water Pollution and Permit Condition Violations-----	1-5
1.4	Additional Water Quality Requirements-----	1-5
1.5	Agencies and Interest Groups-----	1-6
1.5.1	Interest Groups and Citizens-----	1-6
1.5.2	Division of State Lands (DSL)-----	1-6
1.5.3	United States Army Corps of Engineers (USACOE)-----	1-7
1.5.4	United States Department of Agriculture (ODA)-----	1-7
1.5.5	Natural Resource Conservation (NRCS)-----	1-8
1.5.6	Soil Water Conservation District-----	1-8
1.5.7	United States Department of Fish and Wildlife Service (USFWS)-----	1-8
1.5.8	Oregon Department of Fish and Wildlife (ODFW)-----	1-9
1.5.9	National Marine Fisheries Service (NMFS)-----	1-9
1.5.10	Oregon Department of Forestry (ODF)-----	1-9
1.5.11	Metro Regional Government-----	1-10

## **Chapter 2: Erosion Processes**

2.1	Concepts of Erosion and Sedimentation-----	2-1
2.2	Types of Erosion-----	2-2
2.2.1	Water Erosion-----	2-2
2.2.2	Wind Erosion-----	2-3
2.3	Erosion Factors-----	2-4
2.3.1	Climate-----	2-4
2.3.2	Soil-----	2-4
2.3.3	Topography-----	2-6
2.3.4	Ground Cover-----	2-6
2.4	Impacts of Erosion and Sedimentation-----	2-7
2.4.1	Environmental Impacts-----	2-7
2.4.2	Pollutant Sources and Impacts-----	2-7
2.4.2.1	Sediment-----	2-7
2.4.2.2	Nutrients-----	2-8
2.4.2.3	Bacteria-----	2-8
2.4.2.4	Heavy Metals-----	2-9
2.4.2.5	Concrete and Sawcutting-----	2-9
2.4.2.6	Petroleum Hydrocarbons-----	2-9
2.4.2.7	Synthetic Organics-----	2-9
2.5	Economic Impacts-----	2-11

## **Chapter 3: Erosion Control Planning**

3.1	Erosion Prevention vs Sediment Control	3-1
3.1.1	Principles of Erosion Prevention and Sediment Control	3-1
3.2	Five Basic Rules of Planning	3-3
3.3	Designer Responsibilities and Designated Persons	3-4
3.4	Planning Resources	3-5
3.4.1	Soil Survey Information	3-5
3.4.2	Environmental Data	
3.4.3	Climate and Precipitation Data	3-5
3.4.4	Topography	3-6
3.4.5	Revised Universal Soil Loss Equation (RUSLE)	3-6
3.4.6	Agency Contact Information	3-6
3.5	Project Scheduling	3-7
3.6	Developing and Erosion and Sediment Control Plan	3-8

## **Chapter 4: Erosion and Sediment Control Measures and BMPs**

4.1	Erosion Prevention Best Management Practices	4-4
4.1.1	Filter Buffer Zone	4-5
4.1.2	Preserve Natural Vegetation	4-7
4.1.3	Dust Control	4-11
4.1.4	Ground Cover	4-14
4.1.5	Hydraulic Application	4-18
4.1.6	Matting	4-22
4.1.7	Plastic Sheeting	4-30
4.1.8	Seeding (Temporary/Permanent)	4-34
4.1.9	Sod	4-41
4.2	Runoff Control Best Management Practices	4-43
4.2.1	Check Dam	4-44
4.2.2	Diversion Dike/Swale	4-50
4.2.3	Grass-lined Swale	4-54
4.2.4	Outlet Protection	4-58
4.2.5	Pipe Slope Drain	4-63
4.2.6	Surface Roughening	4-69
4.3	Sediment Control Best Management Practices	4-75
4.3.1	Biofilter Bags	4-77
4.3.2	Construction Entrance	4-80
4.3.3	Dewatering	4-84
4.3.4	Filter Berm	4-89
4.3.5	Inlet Protection	4-94
4.3.6	Oak Mats	4-104
4.3.7	Pre-Fabricated Barrier System	4-108
4.3.8	Sand Bags	4-111
4.3.9	Sediment Basin	4-115
4.3.10	Sediment Fence	4-121
4.3.11	Sediment Trap	4-127
4.3.12	Sidewalk Sub-grade Gravel Barrier	4-133
4.3.13	Tire Wash Facility	4-138

4.3.14 Wattles -----4-143

**Chapter 5: Pollution Control Measures and BMPs**

5.1 Management of Other Construction Site Pollutants ----- 5-1  
5.2 Pollution Control Measures and BMPs ----- 5-8

**Chapter 6: Inspection and Maintenance**

6.1 Permittee Site Inspector ----- 6-1  
6.2 Pre-Construction Meeting ----- 6-2  
    6.2.1 Modified ESCP ----- 6-3  
    6.2.2 Construction Schedule Review ----- 6-3  
6.3 Installation of BMPs ----- 6-3  
6.4 Inspection Requirements ----- 6-4  
    6.4.1 Inspection Checklist----- 6-4  
    6.4.2 Inspection of Work Restriction Areas ----- 6-4  
6.5 Stabilization Requirements ----- 6-5  
6.6 Erosion Control Contingency Items ----- 6-5  
6.7 Maintenance ----- 6-5  
    6.7.1 Sediment Removal ----- 6-6  
    6.7.2 Sediment Disposal ----- 6-6  
6.8 Winterization ----- 6-6  
6.9 Designer/Inspector Tool Box ----- 6-6

# Appendices

\*\*\*\*\*

## Appendix A

- Grading & Erosion Control Information
- Erosion Control Notes
- Erosion and Sediment Control Plan Symbols

## Appendix B

- Erosion Control Inspection Log
- Inspector Checklist For Erosion Control

## Appendix C

- Metric Conversion Table
- Slope Conversion Table
- Seed or Fertilizer Hydraulic Application Table A-1
- Wood Fiber Mulch Hydraulic Application Table C-1, C-2
- Hydraulic Application Worksheet
- Example Mulch/Seed Worksheet

## Appendix D

- Acronyms
- Glossary of Terms
- References



## LIST OF DETAIL DRAWINGS

Matting - Slope Installation -----	Pg. 4-26
Matting - Channel Installation -----	Pg. 4-27
Plastic Sheeting -----	Pg. 4-32
Check Dam – Rock -----	Pg. 4-47
Check Dam - Bio-filter Bags-----	Pg. 4-48
Diversion Dike/Swale -----	Pg. 4-56
Outlet Protection - Rip Rap -----	Pg. 4-60
Outlet Protection - Stilling Basin -----	Pg. 4-61
Pipe Slope Drain -----	Pg. 4-67
Surface Roughening – Cat tracking -----	Pg. 4-73
Surface Roughening – Stair Stepping/Grooving -----	Pg. 4-74
Construction Entrance -----	Pg. 4-83
Sediment Bag -----	Pg. 4-87
Filter Berms – Rock/Compost-----	Pg. 4-93
Inlet Protection Curb and Gutter-----	Pg. 4-98
Inlet Protection Type 3 -----	Pg. 4-99
Inlet Protection Type 4 -----	Pg. 4-100
Inlet Protection Type 5 -----	Pg. 4-101
Inlet Protection Type 6 -----	Pg. 4-102
Oak Mats -----	Pg. 4-106
Sediment Basin -----	Pg. 4-119
Sediment Fence -----	Pg. 4-125
Sediment Trap -----	Pg. 4-131
Sidewalk Sub-grade Gravel Barrier -----	Pg. 4-136
Tire Wash –Type 1 and 2-----	Pg. 4-141
Wattles -----	Pg. 4-146
Wattles – Single Family Application-----	Pg. 4-147

This page intentionally left blank.

## **PREFACE**

This Erosion Prevention and Sediment Control Planning and Design Manual was developed through a partnership between Clackamas County Water Environment Services, Clean Water Services, Oak Lodge Water Service District and the cities of Gladstone, Happy Valley, Lake Oswego, Milwaukie, West Linn and Wilsonville.

The purpose of the manual is to provide a comprehensive and detailed approach towards controlling erosion on construction sites. This manual is a guidance document that focuses primarily on the prevention of sedimentation associated with water and wind generated soil erosion. The manual includes the latest information regarding erosion control Best Management Practices (BMPs) and offers details on the proper installation and maintenance of erosion and sediment control BMPs. There are numerous other resources available and readers are encouraged to refer to the reference document listed in Appendix D for additional information.

## CHAPTER 1 BACKGROUND

### 1.1 Introduction

The US Environmental Protection Agency (EPA) has identified erosion as the single largest significant cause of impaired water quality in rivers and streams. Millions of tons of sediment are generated annually by the construction industry in the United States. The rate of erosion on a construction site varies with site conditions, climate, and soil types, but is typically 100 to 200 tons per acre and may be as high as 500 tons per acre. The major problem associated with erosion on a construction site is the movement of soil off the site and its impact on water quality. Sediment in streams is a contributing factor in the decline of Salmonid populations in our region. Sediment fills in clean gravel, which spawning fish need and the increase in turbidity can impair the feeding ability of fish and can clog gill passages. Sediment deposition in wetlands can reduce seed germination and can reduce flood storage.

Sediment laden waters leaving construction sites and entering streams, constitutes a "take" under the Endangered Species Act. This harming and harassing of protected salmon leaves the permittee prone to third party lawsuits by special interest groups, not to mention fines from, state and federal agencies and local jurisdictions.

### 1.2 Regulatory Background and Policies

Water pollution in the United States is regulated under the Clean Water Act (CWA) of 1972. In 1987, Congress amended the CWA to include nonpoint sources of pollution. Nonpoint source pollution occurs when runoff from land carries pollutants to receiving waters. Section 402 of the CWA provides the legal basis for the National Pollution Discharge Elimination System (NPDES) permit program, which regulates point and nonpoint discharges.

The U.S. Environmental Protection Agency (EPA) has delegated the implementation of the National Pollution Discharge Elimination System (NPDES) program to the state of Oregon. The Oregon Department of Environmental Quality (DEQ) administers the NPDES program through Oregon Revised Statute (ORS) 468B and associated Oregon Administrative Rules (OAR). ORS 468B.025 explicitly prohibits the discharge or placement of wastes into waters of the state, prohibits the discharge of waste that causes violations of water quality standards, and prohibits violations of permit conditions.

### 1.3 NPDES Construction Stormwater Permits

It is the local jurisdiction's goal to comply with all conditions of the NPDES permit and other Federal, State, County, and City regulations or requirements. Under existing planning and permitting requirements, the owner/permittee must assure its actions do not harm, jeopardize, threatened or endangered species. In addition, owner/permittee must implement conservation measures, or reasonable and prudent measures identified by the U.S. Fish and Wildlife Services

and the National Marine Fisheries Services, to avoid and minimize potential adverse effects to such species.

In general, the Department of Environmental Quality (DEQ) issues the NPDES 1200-C permit, but through a Memo of Agreement (MOA), some local jurisdictions serve as Agents of DEQ and/or issue a joint permit for projects within their jurisdiction. The 1200-C and the 1200-CN are the construction stormwater permits that address sediment discharge in storm water runoff from construction projects. Most jurisdictions also require a local permit on projects that disturb 500 square feet or more (threshold varies by jurisdiction). In addition, erosion and sediment control measures must be installed prior to any disturbance.

The current 1200-C and 1200-CN regulations can be obtained from the DEQ web site. Below are brief descriptions of each permit:

- **NPDES 1200-C Permit:** The 1200-C permit regulates stormwater runoff to surface waters from construction activities and is required for all projects in the state affecting one or more acres. The permit provides for a public review process for those projects that disturb five acres or more of land.
- **NPDES 1200-CN Permit:** Small-lot construction sites within specific local government agencies' jurisdictions can be managed through local codes and automatically be covered under a NPDES 1200-CN Permit. Coverage under this permit is available only in specific jurisdictions referred to as 1200-CN Jurisdictions.

It is important to note that erosion and sediment control measures must be installed prior to any disturbance. In addition, the owner/permittee should be aware of, and adhere to, any limitations in the work area imposed by environmental permits such as the Division of State Lands (DSL), and U.S. Army Corps of Engineers (USACE) removal/fill permit.

### 1.3.1 NPDES Construction Stormwater Permit Requirements

As the administrator of the NPDES permit, DEQ or its designee has the authority to grant permits for construction activities clearing, grading, excavation, and stockpiling.

Potential pollutant sources covered by this permit include those released through construction activities performed under the authority or jurisdiction of the public agency. Until the permit expires or is modified or revoked, the permittee or the permittee's contractor is authorized to construct, install, modify, or operate erosion and sediment control measures and storm water treatment and control facilities, and to discharge storm water to public waters in conformance with all the requirements, limitations, and conditions set forth within the NPDES permit. Unless authorized by another NPDES permit, all other direct and indirect discharges to public waters are prohibited.

Measures used to comply with the 1200-C and CN permit are called Best Management Practices (BMPs). The primary NPDES mandated controls, limitations and plan requirements are as follows.

1. The permittee shall ensure that an adequate Erosion and Sediment Control Plan (ESCP) is prepared and implemented for each construction activity regulated by this permit and under the authority or jurisdiction of the permittee.
2. A copy of the ESCP, including revisions to the ESCP and visual monitoring records for each construction activity shall be retained on-site and made available to the DEQ, or its designee. During inactive periods of greater than seven consecutive calendar days, the ESCP shall be retained by the permittee. Permit registrant must retain all visual monitoring records for at least three (3) years after termination of permit coverage.
3. The ESCP shall be developed and implemented to prevent the discharge of significant amounts of sediment to surface waters. Under the NPDES 1200-C permit, the following observations are considered significant.
  - a. Earth slides or mud flows that leave the construction site and are likely to discharge to surface waters.
  - b. Evidence of concentrated flows of water causing erosion when such flows are not filtered or settled to remove sediment prior to leaving the construction site and are likely to discharge to surface waters. Evidence includes the presence of rills, gullies, or channels. Flow to storm water inlets or catch basins located on the site will be considered “leaving the site” if there are no sediment control structures downstream of the inlets or catch basins that are under the permittee’s control.
  - c. Turbid flows of water that are not filtered or settled to remove sediment prior to leaving the construction site and are likely to discharge to surface waters. Flow to storm water inlets or catch basins located on the site will be considered “leaving the site” if there are no sediment control structures downstream of the inlets or catch basins that are under the permittee’s control.
  - d. Deposits of sediment at the construction site in areas that drain to unprotected storm water inlets or catch basins that discharge to surface waters. Inlets and catch basins with failing sediment controls due to lack of maintenance or inadequate design will be considered unprotected.
  - e. Deposits of sediment from the construction site on public or private streets outside of the permitted construction activity that are likely to discharge to surface waters.
  - f. Deposits of sediment from the construction site on any adjacent property outside of the permitted construction activity that are likely to discharge to surface waters.
4. DEQ or its designee may require modifications to the ESCP at any time if the ESCP is ineffective at preventing the discharge of significant amounts of sediment to surface waters.
5. Significant amounts of sediment that leave the site shall be cleaned up within 24 hours and placed back on the site or disposed of properly. Any in-stream clean up shall be coordinated with the DSL.
6. Under no conditions shall sediment from the construction site be washed into storm drain sewers or drainage ways.
7. Each ESCP shall include any procedures necessary to meet local erosion and sediment control requirements or storm water management requirements.
8. Each ESCP shall also include, at a minimum, a site description, site map, required controls and practices, additional controls and practices, inspection requirements, inspection requirements for inactive or inaccessible sites, and written records.

### 1.3.2 Penalties for Water Pollution and Permit Condition Violations

The penalties for water pollution and permit condition violations are as follows:

- ORS 468.140 allows DEQ to impose civil penalties up to \$25,000 per day for violation of a term, condition, or requirement of a permit. The federal Clean Water Act provides for civil penalties not to exceed \$37,500 and administrative penalties not to exceed \$16,000 per day for each violation of any condition or limitation of this permit.
- Under ORS 468.943, unlawful water pollution in the second degree, is a Class A misdemeanor and is punishable by a fine of up to \$25,000, imprisonment for not more than one year, or both. Each day on which a violation occurs or continues is a separately punishable offense. The federal Clean Water Act provides for criminal penalties of not more than \$50,000 per day of violation, or imprisonment of not more than 2 years, or both for second or subsequent negligent violations of this permit.
- Under ORS 468.946, unlawful water pollution in the first degree is a Class B felony and is punishable by a fine up to \$250,000, imprisonment for not more than 10 years or both. The federal Clean Water Act provides for criminal penalties of \$5,000 to \$50,000 per day of violation, or imprisonment of not more than 3 years, or both for knowing violations of the permit. In the case of a second or subsequent conviction for knowing violation, a person is subject to criminal penalties of not more than \$100,000 per day of violation, or imprisonment of not more than 6 years, or both.
- Local jurisdictions may also levy fines for permit violations and violation of local erosion program requirements.

### 1.4 Additional Water Quality Requirements

Additional water quality requirements that are in place or are being developed may have a significant impact on erosion prevention and sediment control requirements. The following are statewide standards that are in place and need to be considered:

- Total Maximum Daily Loads (TMDLS) – set the amount of certain pollutants a waterway can receive without violating water quality standards. A plan is then developed and put in to place to reduce the levels of these pollutants.
- Turbidity Standards – Turbidity is a measure of cloudiness in water. It can be caused by soil erosion, water discharge and runoff. High turbidity levels mean that water bodies contain a denser amount of particles. Turbidity may adversely affect a wide range of aquatic species, including endangered fish.
- Underground Injection Control (UIC) – rules for subsurface drainage systems that are designed to distribute storm and surface water below the ground surface (e.g. drywells/sumps, certain types of “French drains”, etc.). These rules are associated with the Safe Drinking Water Act and are designed to help protect aquifers from contamination.

More information is available on the DEQ website and through your local jurisdiction.

### 1.5 Agencies and Interest Groups

During the planning process, developers, designers should coordinate meetings with interest groups and public agencies or jurisdictions that may either have an interest in, or control of the impacts of proposed development. This process provides a means for interested parties to supply input regarding erosion and sediment controls, environmentally sensitive areas, and other regulated activities.

The development of an ESCP spans the entire planning, design, and construction stages of a project. To be successful, it is imperative that communication among the interested parties be established and maintained throughout each stage of development and in accordance with Federal, State, and local agencies requirements. Some of the principle agencies and interested parties are described in the following sections.

#### 1.5.1 Interest Groups & Citizens

Citizen advisory committees, watershed councils, friends groups and neighborhood associations are taking a more active role with growth of their communities. Civic and environmental values have become an integral part of the land use process. This collaborating with local governments has created a more responsive method for planning urbanization and protecting the natural features that add to the livability of our watersheds.

Watershed restoration is an excellent way to enhance community volunteerism in our rapidly urbanizing areas. Local municipalities have developed an advantageous working relationship with civic-minded groups. Communities taking ownership of their local watersheds has proven advantageous to the environment.

#### 1.5.2 Department of State Lands (DSL)

Department of State Lands (DSL) was first established in 1878 as the Office of the Clerk of the Land Board and is one of Oregon's oldest state agencies. It was renamed and elevated to Executive Agency status by the 1967 State Legislature. DSL manages the state's submerged and submersible lands under navigable rivers, lakes, estuaries, and the territorial sea to maintain fisheries, commerce, recreation, and navigation.

DSL is a regulatory agency, responsible for administration of Oregon's Section 401 Removal-Fill Law. That law, enacted in 1967, is intended to protect, conserve and allow the best use of the state's water resources. A permit is required from DSL to remove, fill or alter more than 50 cubic yards of material within the bed or banks of waters of the state.

Exceptions are in State Scenic Waterways and areas designated essential salmon habitat, where a permit is required for all in-stream activity, regardless of size.

DSL also is responsible for Oregon's wetlands program. This includes maintenance of a statewide wetland inventory, providing public information and technical assistance about



wetlands to local governments and landowners, and providing wetland conservation grants to local governments conducting detailed wetland inventories.

### **1.5.3 United States Army Corps of Engineers (USACOE)**

Army Corps of Engineers (ACOE), principal engineering component of the United States Army, dates from June 16, 1775, when the Continental Congress authorized a chief engineer and two assistants for the army. They prepared the fortifications for the Battle of Bunker Hill. The engineers were permanently organized into a corps in 1802.

The present work of the corps is divided between military and civil projects. The program currently includes construction for the army and air force and environmental restoration of areas contaminated by toxic wastes. The civil program centers on development of water resources, including navigation improvement, hydroelectric power, flood control, recreation, and conservation of fish and wildlife. When requested, the corps provides engineering expertise to other agencies, state and local governments. The work ranges from constructing wastewater treatment plants and space launch facilities to other complex engineering tasks. Engineering professionals help remove toxic wastes and help other nations with the damage caused by disasters and wars.

DSL and ACOE have developed a joint permit application process. Although the regulatory authorities of DSL and ACOE are different, their roles, when considered together, include protecting navigable waters (and the ocean), ensuring wise and beneficial water use, maintaining and enhancing water quality, protecting fish and wildlife habitat and recreation resources, and in general, protecting the public interest.

Joint permit applications, after receipt, are forwarded to the DEQ, or its designee for review to ensure that it does not endanger Oregon's streams and wetlands and to confirm that the plans meet water quality laws and standards. Frequently, applicants are required to incorporate protective measures into their construction and operational plans, such as bank stabilization, treatment of storm water runoff, spill protection, and fish and wildlife protection.

### **1.5.4 United States Department of Agriculture (USDA)**

The U.S. Department of Agriculture (USDA) offers landowners financial, technical, and educational assistance to implement conservation practices on privately owned land. Using this help, farmers, ranchers, and forest landowners apply practices that reduce soil erosion, improve water quality, and enhance cropland, forestland, wetlands, grazing lands, and wildlife habitat. Incentives offered by USDA promote sustainable agricultural and forestry practices, which protect and conserve valuable farm and forestland for future generations. USDA assistance also helps individuals and communities restore natural resources after floods, fires, or other natural disasters.

### **1.5.5 Natural Resources Conservation Service (NRCS)**

The Natural Resources Conservation Service (NRCS), formerly called the Soil Conservation Service, was born of adversity, a national response to the Dust Bowl catastrophe of the mid-1930s. The agency's first chief, Hugh Hammond Bennett, spoke eloquently for the land when he convinced Congress that soil erosion was a national menace, that a permanent agency was needed within the Department of Agriculture to call landowners' attention to their land stewardship opportunities and responsibilities, that a nationwide partnership of Federal agencies with local communities was needed to help farmers and ranchers conserve their land.

NRCS is the U.S. Department of Agriculture's lead conservation agency. Its partners include conservation districts, state and federal agencies, NRCS Earth Team volunteers, agriculture and environmental groups, and professional societies. The strength of NRCS is in its workforce. They are based out of county, state, regional, and national offices and specialize in soil science, soil conservation, agronomy, biology, agroecology, range conservation, forestry, engineering, geology, hydrology, cultural resources, and economics.

### **1.5.6 Soil & Water Conservation District (SWCD)**

The first SWCD in Oregon was established in Tillamook County in 1941. Presently there are forty-five conservation districts in Oregon, providing services to private landowners and managers statewide. There is at least one conservation district in each Oregon County. Soil and Water Conservation Districts are political subdivisions of state government and are under the administrative oversight authority of the Oregon Department of Agriculture. When the first conservation districts were formed, their focus was on soil erosion control in rural areas. Once considered primarily agriculturally oriented, many conservation districts are now actively involved in urban water quality and quantity issues, such as land uses and run off from construction sites, and in assisting landowners with just a few acres.

Perhaps the most important responsibility of the Soil and Water Conservation District is to conduct research relating to the character of soil erosion, the character of floodwater and sediment damage. They also develop comprehensive plans and specifications for the conservation of soil resources and for the continued control and prevention of soil erosion.

### **1.5.7 United States Department of Fish and Wildlife Service (USFWS)**

The U.S. Fish and Wildlife Service is the federal regulatory agency authorized to enforce the provisions of the Endangered Species Act and the Migratory Bird Act. The USFWS ensures that federal actions do not jeopardize listed species or destroy or adversely modify critical habitat. This applies to management of federal lands as well as other federal actions that may affect listed species, such as federal approval of private activities through the issuance of federal permits, licenses, or other actions.

### **1.5.8 Oregon Department of Fish and Wildlife (ODFW)**

The Oregon Department of Fish & Wildlife is made up of predominately fish and wildlife biologists. Their main responsibility is to protect fish and wildlife as well as their habitat throughout the entire State of Oregon. Their key audiences are fishing & hunting license holders, unorganized wildlife enthusiasts, organized conservation groups, legislators and the media. ODFW has the authority to seek damages in a court of competent jurisdiction for the value of fish and wildlife injured or killed as the result of pollution or violation of the condition of any permit. The damages could include all costs for restoring the production of fish and wildlife in the affected areas.

ODFW works cooperatively with other state and federal agencies to eliminate sources of pollution or other environmental damage, to prevent natural resource losses through educational efforts and through enforcement of anti-pollution and other environmental laws, and to ensure that violations of anti-pollution and other environmental laws are pursued to the fullest extent of the law.

### **1.5.9 National Marine Fisheries Service (NMFS)**

The National Marine Fisheries Service (NMFS) is a part of the National Oceanic and Atmospheric Administration (NOAA). NMFS administers NOAA's programs to conserve, protect and manage living marine resources. The Protected Resources Division (PRD), located in Portland, Oregon, provides program oversight, and regional policy guidance on the conservation of at-risk anadromous, estuarine, and marine fishes in the NMFS Northwest Region. The PRD staff includes biologists, natural resource specialists, and policy analysts who work in conjunction with other NMFS programs to help administer provisions of the Endangered Species Act (ESA).

NMFS is dedicated to the protection of marine resources including salmon and trout that live at least part of their lives at sea. Due to declining numbers, certain populations have been listed as endangered or threatened under the Endangered Species Act. The ESA protects these fish and the habitats they depend on as they migrate to and from the Pacific Ocean. Along with federal protection under the ESA, state laws apply additional safeguards for the fish and their habitats.

Protection of water quality sensitive areas and restoration of vegetated corridors are important because once protective regulations enacted through the ESA are issued, NMFS requires that all parties must avoid killing or harming a listed species, and avoid adverse affects to the habitat that supports listed species.

### **1.5.10 Oregon Department of Forestry (ODF)**

The ODF manages several programs, which protect the State's forestlands and ensure a plentiful natural resource. The Department's largest program protects the roughly 16,000,000 acres of forestland from wild fire. The Forest Practices program assures the growing and harvesting of forest tree species and maintenance of forestland for forest purposes are the primary uses of

privately owned forestlands. The program also assures that forest practices are consistent with the sound management of soil, air, water, fish, and wildlife resources. Like many of the other environmental agencies, the ODF provides technical and financial assistance. By providing this service, it helps to mitigate Oregon's future timber supply shortage while it promotes forest health. It also enhances and protects critical natural resource values such as fish and wildlife habitat, soils, air, water, recreation, and aesthetics on non-federal forestland.

### **1.5.11 Metro Regional Government – Stream and Floodplain Protection Plan (Title 3)**

The goal of the Stream and Floodplain Protection Plan (Title 3) is to protect the region's health and public safety by reducing flood and landslide hazards, controlling soil erosion, and reducing pollution of the region's waterways.

Title 3 specifically implements the Oregon Statewide Land Use Goals 6 and 7 by protecting streams, rivers, wetlands, and floodplains by avoiding, limiting or mitigating the impact on these areas from development.

Title 3 contains performance standards to protect against flooding. The standards limit development in a manner that requires balanced cut and fill and floor elevations at least one foot above the flood hazard standard. The areas subject to these requirements have been mapped and adopted by Metro Council. The areas are the FEMA 100-year floodplain and the area of inundation for the February 1996 flood.

The purpose of these standards is to protect and allow enhancement of water quality. The water quality areas are rivers and streams with a protected vegetated corridor width depending on the slope of the stream and the number of acres drained by the stream. The performance standards require erosion and sediment control, planting of native vegetation on the stream banks when new development occurs, and prohibition of the storage and uses of hazardous material in water quality areas.

Finally, the functional plan directs Metro to establish performance standards to protect regionally significant fish and wildlife habitat areas. Those seeking to develop sites within these sensitive areas must contact their local jurisdictions to determine buffer width.

## CHAPTER 2

### EROSION PROCESSES

#### 2.1 Concepts of Erosion and Sedimentation

Erosion is a natural process by which soil and rock material is loosened and transported. Erosion by the action of water, wind, and ice has produced some of the most spectacular landscapes. Natural erosion occurs primarily on a geologic timescale, but when human activities alter the landscape, the process of erosion can be greatly accelerated.

When land is disturbed at a construction site, the erosion rate accelerates dramatically. Uncontrolled construction site erosion can cause serious and costly problems, both on-site and off-site (refer to Figure 2-1). Since ground cover on an undisturbed site protects the surface, the removal of that cover increases the site's susceptibility to erosion. Disturbed land may have an erosion rate 1,000 times greater than the pre-construction rate. Even though the process of construction requires that land be left bare for periods of time, proper planning and use of erosion prevention measures can reduce the impact of accelerated erosion caused by land development.

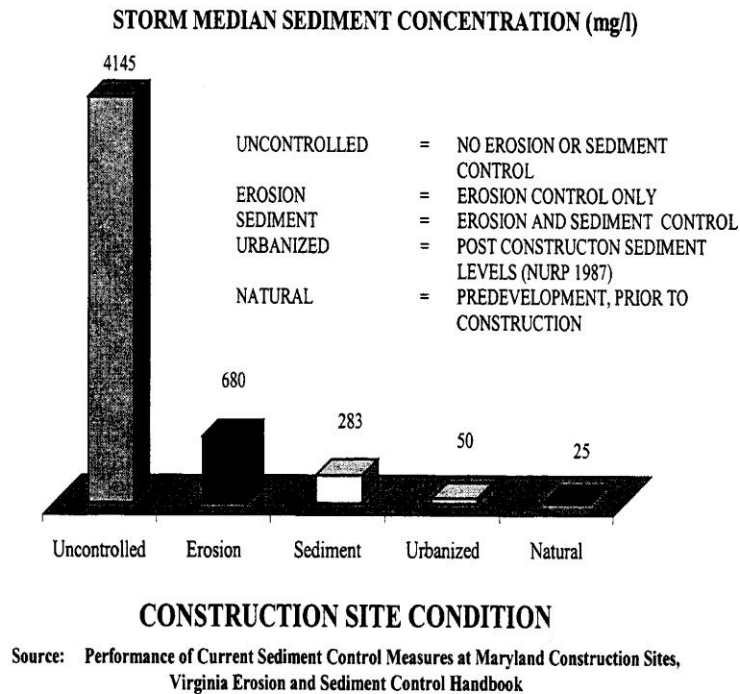

**Figure 2-1 Absence of surface cover increases the soil susceptibility to erosion**

When combined with an understanding of basic erosion control and sedimentation processes, fundamental erosion prevention and sediment control principles will lay the groundwork for successful implementation of erosion and sediment control best management practices. Soils, topography, and drainage patterns of a specific site may influence the potential for soil erosion. Identifying potential erosion problems at the planning stage and recognizing highly erodible areas will help in selecting effective erosion control practices.

## 2.2 Types of Erosion

Erosion is often described as the detachment of soil particles by some force. This force may be due to rainfall, wind, or other forces. Once detachment occurs, the particles are transported. This is most often caused by water action, although wind can also be a major contributor.

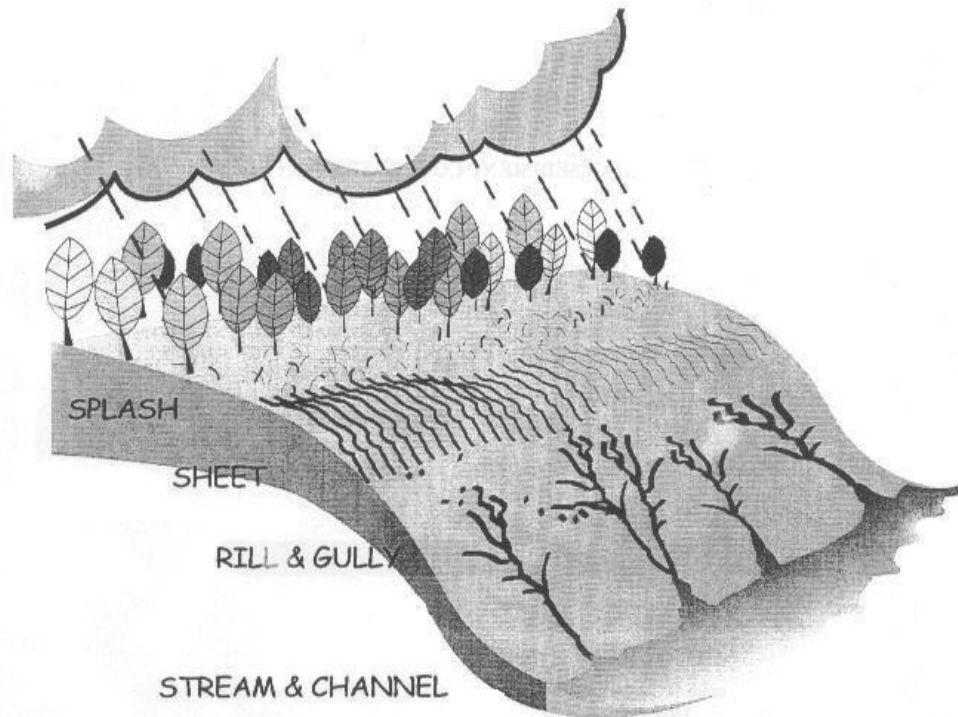

Figure 2-2 Major types of soil erosion

### 2.2.1 Water Erosion

Water erosion is the result of rain detaching and transporting soil, either directly by means of rain splash or indirectly by rill and gully erosion. The major types of water erosion are:

**Splash** – When vegetative cover is stripped away, the soil surface is directly exposed to raindrop impact. Splash erosion results when the force of raindrops falling on bare or sparsely vegetated soil detaches soil particles that can easily be transported by runoff. This pounding action destroys the soil structure and often a hard crust forms when the soil dries. This crust inhibits water infiltration and plant establishment, increasing runoff and future erosion.

**Sheet** – The removal of exposed surface soil can be caused by the action of unchanneled surface runoff. Shallow “sheets” of water flowing over the soil surface cause sheet flow. Sheet flow transports soil particles that have been detached by splash erosion. The shallow surface flow rarely moves as a uniform sheet for more than a few feet before concentrating in the surface irregularities.

**Rill** – As surface flow changes from sheet flow to deeper concentrated flow along the low spots of the soil surface it creates rivulets, cutting grooves called rills into the soil surface. The energy of this concentrated flow is able to both detach and transport soil particles. The rills are small but well-defined channels that are at most only a few inches deep.

**Gully** – Some gullies are formed when runoff cuts rills deeper and wider or when the flows from several rills come together and form a large channel. Gullies can enlarge in both uphill and downhill directions. If the flow of water is sufficient, large chunks of soil can fall from a gully headwall in a process called mass wasting. Once a gully is created, it is very difficult to control, and costly to repair.

**Channel** – When stream bank vegetation is disturbed or when the velocity or volume of a stream is increased, channel erosion can occur. Natural streams have adjusted over time to the quantity and velocity of runoff that normally occurs within a watershed. The vegetation and rocks lining the banks are sufficient to prevent erosion under these steady-state conditions. When a watershed is altered by removing vegetation, by increasing the amount of impervious surfaces, or by paving tributaries, stream flows are changed. Increased volume and velocity of runoff may cause expansion of gullies into well-defined channels. These changes can disturb the equilibrium of the stream and cause channel erosion to begin. Channel erosion is commonly found at stream bends, constrictions where installed structures control the stream flow, or discharge points where storm drain culverts release storm water into a stream.

### 2.2.2 Wind Erosion

Wind erosion is a form of erosion occurring in flat, bare areas dry, sandy soils, or where the soils are loose, dry, and finely granulated. Wind erosion damages land and natural vegetation by removing soil from one place and depositing it in another. It causes soil loss, dryness and deterioration of soil structure, nutrient and productivity losses, air pollution and sediment transport and deposition. Soil movement is initiated as a result of wind forces exerted against the surface of the ground. For each specific soil type and surface condition there is a minimum velocity required to move soil particles. This is called the threshold velocity. Once this velocity is reached, the quantity of soil moved is dependent upon particle size, the cloddiness of particles, and wind velocity itself.

**Suspension** – Suspension occurs when very fine dirt and dust particles are lifted into the wind. They can be thrown into the air through impact with other particles or by the wind itself. Once in the atmosphere, these particles can be carried very high and be transported over extremely long distances. Soil moved by suspension is the most spectacular and easiest to recognize of the three forms of movement.

**Saltation** – The major fraction of soil moved by wind is through the process of saltation. In saltation, fine soil particles, are lifted into the air by the wind and drift horizontally across the surface, increasing in velocity as they go. Soil particles moved in the process of saltation cause severe damage to the soil surface and vegetation. They travel approximately four times longer in distance than in height. When they strike the surface again, they either rebound back into the air or knock other particles into the air.

**Surface Creep** – The large particles which are too heavy to be lifted into the air are moved through a process called surface creep. In this process, the particles are rolled across the surface after coming into contact with the soil particles in saltation.

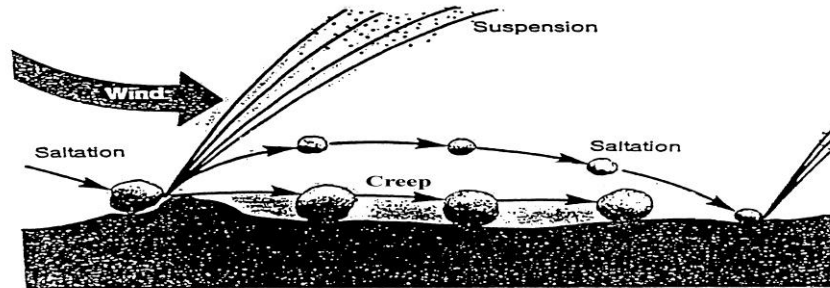

### 2.3 Erosion Factors

The four principal factors in soil erosion are climate, soil characteristics, topography and ground cover. These factors are interrelated in their effect on erosion potential. The variability in Oregon's terrain, soils, and vegetation makes erosion control unique to each construction site. Understanding the factors that affect the erosion process enables us to make useful predictions about the extent and consequences of on-site erosion.

An empirical model developed for agriculture applications, the Revised Universal Soil Loss Equation (RUSLE) predicts soil loss resulting from sheet and rill erosion. It considers both the effects of erosion control practices and the factors that influence erosion, so it is useful for evaluating erosion problems and potential solutions.

#### 2.3.1 Climate

Climate affects erosion potential both directly and indirectly. In the direct relationship, rain is the driving force of erosion. Raindrops dislodge soil particles, and runoff carries the particles away. The erosive power of rain is determined by rainfall intensity (millimeters of rain per hour) and droplet size. A highly intense rainfall of relatively short duration can produce far more erosion than a long duration storm of low intensity. In addition, storms with large raindrops are much more erosive than misty rain events with small droplets. Oregon has considerable diversity of climate. Rainfall intensity, duration, and droplet size vary according to geographic location.

#### 2.3.2 Soil

Soil is a product of its environment. A soil's erodibility, or the vulnerability of soil to erosion, is a result of a number of soil characteristics, which can be divided into two groups: those influencing infiltration, or the movement of water into the ground, and those affecting the resistance to detachment and transported by rainfall and runoff. Key factors that affect erodibility are soil texture, amount of organic matter, soil structure, and soil permeability.



## CHAPTER 2: EROSION PROCESSES

- Soil texture refers to the sizes and proportions of the particles making up a particular soil. Sand, silt, and clay are the three major classes of soil particles. Soils high in sand content are said to be coarse-textured. Because water readily infiltrates sandy soils, the runoff, and consequently the erosion potential, is relatively low. Soils high in content of silts and clays are said to be fine-textured or heavy. Clay, because of its stickiness, binds soil particles together and makes a soil resistant to erosion. However, once heavy rain or fast flowing water erodes the fine particles, they will travel great distances before settling.
- Organic matter consists of plant and animal litter in various stages of decomposition. Organic matter improves soil structure and increases permeability, water holding capacity, and soil fertility. Organic matter in an undisturbed soil or in mulch covering a disturbed soil reduces runoff and erosion potential. Mulch on the surface also cushions the soil from erosive impact of raindrops.
- Soil structure is the arrangement of soil particles into aggregates. Soil structure affects the soil's ability to absorb water. When the soil is compacted or crusted, water tends to run off rather than infiltrate. Erosion hazard increases with increased runoff. A granular structure is the most desirable one. Loose granular soils absorb and retain water, which reduces runoff and encourages plant growth.

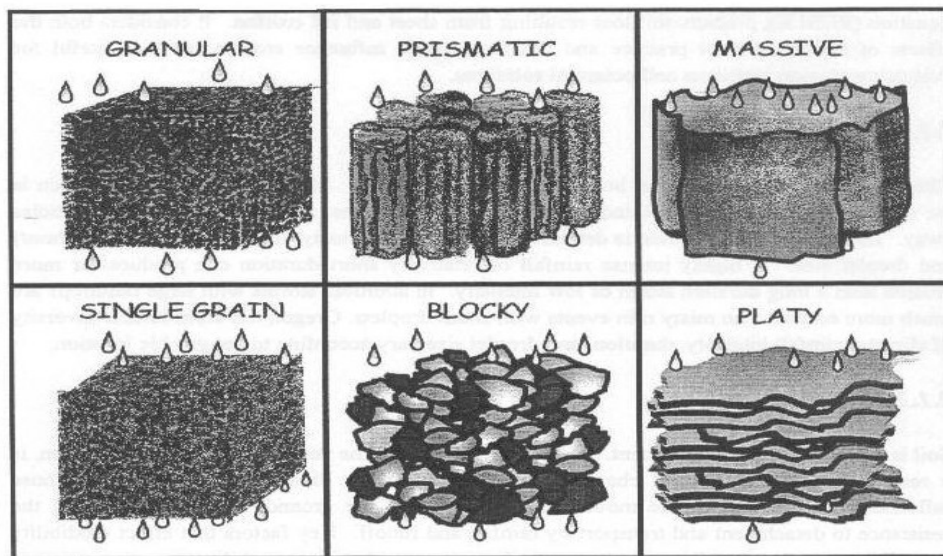

Figure 2-3 Soil Structure

- Soil permeability refers to the ability of the soil to allow air and water movement through the soil. Soil texture, structure, and organic matter all contribute to permeability. Soils that are least subject to erosion from rainfall and shallow surface runoff are those with high permeability rates, such as well-graded gravels and gravel-sand mixtures. Loose, granular soils reduce runoff by absorbing water and by providing a favorable environment for plant growth.

### 2.3.3 Topography

Topographic features distinctly influence erosion potential. Watershed size and shape, for example, affect runoff rates and volumes. Long, steep slopes increase runoff flow velocity. Ditches and channels can concentrate surface flow, which results in higher velocities. Slope length and slope steepness are critical factors in erosion potential, since they determine in large part the velocity of runoff. Long, continuous slopes allow runoff to build up momentum. The high velocity runoff tends to concentrate in narrow channels and produce rills and gullies.

The shape of a slope also has a major bearing on erosion potential. The base of a slope is more susceptible to erosion than the top, because runoff has more momentum and is more concentrated as it approaches the base. Slope orientation can also be a factor in determining erosion potential. In northern latitudes, exposed south-facing soils are hotter and drier, which makes vegetation difficult to establish. Northern exposures tend to be cooler and moister, receiving less sunlight, which results in slow plant growth.

### 2.3.4 Ground Cover

The term ground cover refers principally to vegetation, but it also includes surface treatments such as mulches, matting, wood chips, and crushed rock. Vegetation is the most effective means of stabilizing soils and controlling erosion. It shields the surface from the impact of falling rain, reduces flow velocity, and disperses flow. Vegetation provides a rough surface that slows the runoff velocity and promotes infiltration and deposition of sediment. Plants remove water from the soil and thus increase the soil's capacity to absorb water. Plant leaves and stems protect the soil surface from the impact of raindrops, and the roots help maintain the soil structure while holding the soil in place.

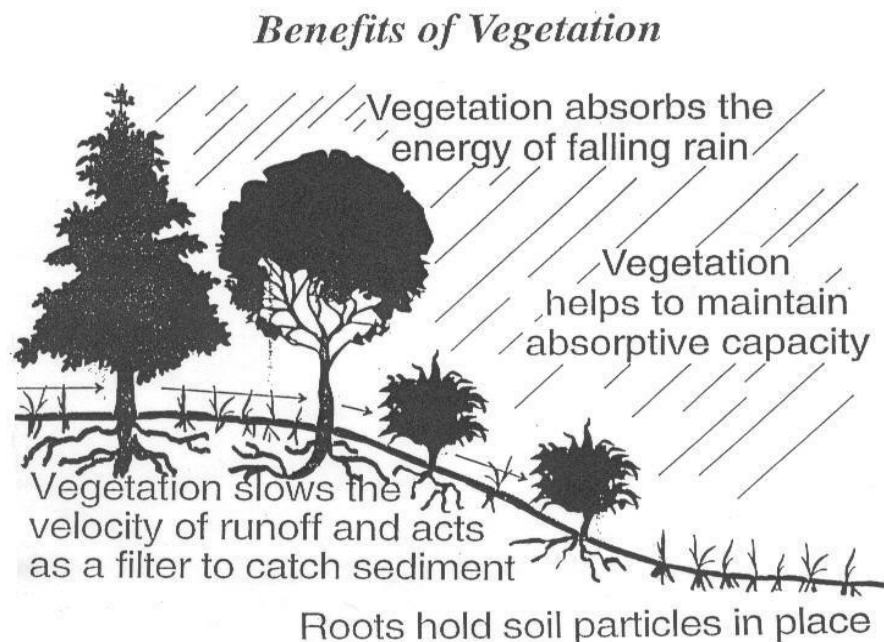

### 2.4 Impacts of Erosion and Sedimentation

Erosion and sedimentation cause both environmental and economic impacts. Both are important, but often only the economic impact spurs a jurisdiction to take action. Erosion and sedimentation can cause expensive site damage and construction delays and produce environmental impacts that can be difficult to correct.

#### 2.4.1 Environmental Impacts

Many environmental impacts from sediment pollution are cumulative and the ultimate results and costs may not be evident until years later.

- Eroded soil can contain nitrogen, phosphorus, and other nutrients. When carried into water bodies, these nutrients can trigger algal blooms that reduce water clarity, deplete oxygen, lead to fish kills, and create odors.
- Erosion of streambanks and adjacent areas can destroy streamside vegetation that provides aquatic and wildlife habitats.
- Excessive deposition of sediments in streams can smother the bottom fauna, seal stream beds, and destroy fish spawning habitat.
- Turbidity from sediment can reduce in-stream photosynthesis, which leads to reduced food supply and habitat.
- Turbidity can increase the amount of sunlight absorbed in water, raising stream temperatures.
- Suspended sediment can abrade and coat aquatic organisms.
- Erosion removes the smaller and less dense constituents of topsoil, including clays, fine silt particles and organic materials that hold nutrients that plants require for healthy establishment. The remaining subsoil is often hard, rocky, infertile, and droughty; thus making reestablishment of vegetation difficult.

#### 2.4.2 Pollutant Sources and Impacts

Pollutants, as the term applies to our subject, are substances that can render water harmful to people, fish, or wildlife, or impair recreation or other beneficial uses. Sediments, nutrients, bacteria, oxygen-demanding materials, heavy metals, petroleum hydrocarbons, and synthetic organic chemicals are the most important classes of pollutants. Heavy metals, petroleum-hydrocarbons and synthetic organics are frequently classified as toxic pollutants, depending on their characteristics.

This section covers potential impacts on natural systems associated with pollutants from construction activities. Table 2-1 provides an overview of important pollutant categories and some of their effects on the environment.

##### 2.4.2.1 Sediment

Sediments and other suspended solids are the most common pollutant in storm water runoff. Erosion and sediment loss from a site occur most commonly because of vegetation removal.

Soils exposed during construction, mining, logging or agriculture can contribute substantial quantities of sediment to nearby water bodies. Construction site erosion is one of the primary contributors.

Suspended particles, or turbidity, turn water cloudy, degrading aquatic habitats and can increase the cost of maintaining storm drainage facilities. Deposited sediments can affect adjacent properties and clog catch basins and storm drains, causing flooding and higher maintenance costs. When sediments enter streams and lakes, they create cloudy or turbid water conditions. This condition interferes with recreational use and enjoyment, and affects fish and other aquatic life habitats. For example, sediments can make it difficult for fish to feed and breathe, cover gravels needed by salmon and trout for spawning and rearing, and smother fish eggs and aquatic insects on which fish feed. In addition, sediments can transport many other pollutants, including nutrients, bacteria, metals and some organic pollutants.

### **2.4.2.2 Nutrients**

Plants require nutrients such as phosphorus and nitrogen for growth, but excessive levels in receiving waters can harm water quality. Excess nutrient levels over-stimulate the growth of algae and other aquatic plants, potentially causing unpleasant tastes, odors, unsightly conditions and lowered dissolved oxygen levels from plant decay. Nutrients tend to be more of a problem in slow moving water such as lakes or sluggish streams. Sources of nutrients include organic and inorganic fertilizers, soils and decomposing vegetation.

### **2.4.2.3 Bacteria**

The presence of disease-bearing organisms in surface waters, such as bacteria and viruses, potentially threatens public health. Fecal coliform bacteria are often used as an indicator for such pathogens, even though generally they are not pathogenic themselves. The presence of fecal coliforms, however, indicates that warm-blooded animal waste is present. The most common impacts associated with fecal coliform pollution are closed (decertified) shellfish growing areas and reduced recreational opportunity. Potential construction site sources of fecal coliforms include outhouses that are not maintained or pumped out on a regular basis. The clearing and grading process can also expose waste, deposited prior to construction, to runoff.

Bacterial decomposition of plant, animal and chemical wastes requires oxygen. When this process occurs in water, it reduces the oxygen available for fish and other aquatic organisms. If dissolved oxygen levels become too low, fish and other aquatic organisms may become stressed or die.

Construction sites can be a source of oxygen-demanding substances. For example, cleared vegetation, exposed soils, spilled chemicals, and animal or human wastes can all contribute to lower oxygen levels in water.

### 2.4.2.4 Heavy Metals

Many metals are toxic and are regulated by the Environmental Protection Agency (EPA). Specifically, EPA classifies eight metals (arsenic, barium, cadmium, chromium, lead, mercury, selenium and silver) as hazardous and regulates their disposal. Construction materials or equipment that contain such metals include paints, preservatives, metal downspouts, brake linings and tires. Other metal sources are wastes such as used automotive liquids, fuels, dust from sanding or grinding metal and painted surfaces, and wash from roadways.

Metals such as copper and zinc, which partially dissolve in water, may create toxic conditions for fish and other aquatic life. A large number of metals in construction site runoff can attach to sediments and other particles. Sediments carrying heavy metals such as mercury often settle out from water and accumulate on stream and lake bottoms where they can remain for a long time. The metals accumulate in the tissue of organisms, which are then eaten by predators near the top of food chains. High concentrations of heavy metals can sometimes be found in these predators.

### 2.4.2.5 Concrete and Sawcutting

Concrete/mortar washwater and sawcutting residues can be highly alkaline and contain a high amount of suspended sediments. These are harmful to people, plants, fish & wildlife if discarded improperly. In addition, when concrete wastes solidify or build up in stormwater structures and facilities, they block the drainage flow, causing localized flooding. This can result in property damage and unsafe driving conditions as well as increased maintenance costs.

### 2.4.2.6 Petroleum Hydrocarbons

Petroleum hydrocarbons include crude oil and any products derived from it in the refining process, such as gasoline, diesel fuel, industrial and home heating fuels, and lubricating oils. Petroleum products can be present in a number of forms on a construction site, principally as vehicle fuels, cleaning solvents, and lubricants. If released to the environment, they can harm water quality in various ways. Certain petroleum products contaminate water supplies. They are acutely toxic and kill fish and invertebrate life. Petroleum products also consume oxygen as they decay naturally and greatly reduce the aesthetic quantities of water bodies for human enjoyment. As a result of these potentially severe impacts, petroleum products require special care during storage, transfer, and usage on construction sites.

### 2.4.2.7 Synthetic Organics

Synthetic organics contain carbon and are any type of chemical produced through industrial or combustion processes. Synthetic organic substances include most pesticides, preservatives, solvents, and plasticizers, as well as incidental and unwanted by-products of fuel combustion. Many organics, depending on their composition and rate of degradation, are slow to degrade and remain in the environment for long periods of time. Synthetic organics can be quite toxic to fish and other aquatic life and are sometimes classified as carcinogenic (cancer causing).

## CHAPTER 2: EROSION PROCESSES

Organics include common pesticides and the ingredients of many common household and industrial chemicals. Pesticides, by their very purpose, are designed to kill and can do the same in receiving waters.

Organics can be liquid or solid products, or waste materials. Liquid and solid products may enter the environment when they leak or are spilled from containers during use or transfer, are carried away by rain water and wash water, or are spilled or dumped on the ground or down the storm drain. Therefore, they also warrant a special consideration for careful inspection at construction sites.

**TABLE 2-1. OVERVIEW OF POLLUTANT SOURCES, IMPACTS, AND INDICATORS**

<b>POLLUTANTS</b>	<b>MAJOR SOURCES</b>	<b>IMPACTS</b>	<b>INDICATORS</b>
Sediments and other solids	Clearing/grading exposed soils	Cloudy water, smothering of fish eggs and insects, flooding	Total suspended solids, turbidity
Nutrients	Cleared vegetation exposed soils human/animal waste, fertilizer, moss killer	Algal blooms, reduced oxygen, aquatic plant growth	Different forms of phosphorus and nitrogen
Bacteria	Human/animal wastes, sewer lines, septic tanks	Shellfish contamination, human health effects	Fecal coliforms
Oxygen demanding materials	Cleared vegetation, human/animal waste, chemical reactions	Reduced oxygen in water, stress/kill salmonid fish and other aquatic life	Biological Oxygen Demand (BOD), Chemical Oxygen Demand (COD), dissolved oxygen
Heavy metals	Paints, flashings, downspouts, tires, brake linings, preservatives, disturbed soils, solvents	Bioaccumulation in food chain, toxic to aquatic life, human health effects	Ar, Cd, Cu, Hg, Ni, Pb, Zn
Petroleum hydrocarbons	Oil, grease, fuels, lubricants	Decreased oxygen levels, aesthetics, human, aquatic and wildlife health effects	Oil & grease, total petroleum hydrocarbons
Concrete/Aggregates	Cement, sand, aggregates, chemical admixtures, fuels and lubricants.	Highly alkaline and toxic to fish and other aquatic organisms.	Increase pH, turbidity, Cr
Synthetic organics	Pesticides, pcb's, combustion products, solvents	Bioaccumulation in food chain, toxic to aquatic life, wildlife and humans	Variety of organics analyses

### 2.5 Economic Impacts

Many economic impacts are hard to quantify. How can a dollar value be assigned to loss of aquatic habitat or diminished water clarity? Other impacts may be readily quantified, for example the cost of dredging and disposing of the accumulated sediment in a silted-up reservoir or swale. The list below are some examples of the economic consequences of construction site erosion:

- Excessive sediment accumulation reduces reservoir storage capacity and more frequent sediment removal is required. The cost of building new reservoirs to replace lost reservoir capacity is high. Increasing land values and lack of available sites are making this alternative much less feasible.
- Sediment discharged into the conveyance system such as catchbasins or water quality facilities requires sediment removal and increases maintenance costs.
- Sediment deposited into waterways reduces flow capacity, interferes with navigation, and increases the risks of flooding. Regular maintenance dredging is required.
- Erosion severely diminishes the ability of the soil to support plant growth. To restore this ability is costly.
- Listing additional wildlife as endangered species increases time and fees for permitting, design, and construction in the affected watersheds. Some costs are directly assessed to specific projects while many other costs are distributed statewide by spending additional monies for habitat restoration.

This page intentionally left blank.



## **CHAPTER 3**

### **EROSION CONTROL PLANNING**

The purpose of erosion and sediment control planning is to establish erosion control measures that are intended to prevent erosion and off-site sedimentation during construction. The Erosion and Sediment Control Plan (ESCP) serves as a blueprint for the location, installation, and maintenance of practices to control erosion and prevent sediment from leaving the site during construction. The driving consideration in creating and implementing an effective ESCP is to provide erosion prevention measures rather than sediment control. Although every ESCP will have elements of both, it is often far more cost effective and practical to emphasize erosion prevention. It should be understood that plans are only a blueprint and will require modification throughout the life of the project

#### **3.1 Erosion Prevention vs. Sediment Control**

***Erosion prevention*** - Defined as any practice that protects the soil surface and prevents the soil particles from being detached by rainfall or wind. Erosion prevention is a prevention technique that treats the soil as a valuable resource that should be kept in place. The benefit of erosion prevention is that it seeks to prevent the problem before it starts.

Erosion prevention measures are more effective than the reactive control of capturing sediment. It is often impractical to recover large amounts of sediment after it becomes dislodged and suspended in runoff. Once soil particles become dislodged, it requires greater effort and cost to contain the sediment on the site. In fact, it is generally true that erosion prevention measures are more reliable, whereas sediment control measures require continual and costly maintenance. Erosion prevention measures include temporary ground covers (mulch, temporary grasses, straw mulch and tackifier, etc.), matting, plastic sheeting, and numerous other products designed to provide mechanical or physical protection to exposed soil.

***Sediment Control*** - Once soil erosion has occurred sediment control measures are used to trap sediment and recapture techniques will reduce the amount of sediment and associated pollutants that leave the site. Sediment leaving the site may damage neighboring properties, block drainage systems, and enter waterways. Local government budgets can be adversely impacted by the cost to remove the sediment from streets, sewers, ditches and culverts. Sediment control measures include sediment traps and basins, sediment fences, check dams, sediment barriers, catch basin filters, etc.

##### **3.1.1 Principles of Erosion Prevention and Sediment Control**

Effective erosion and sedimentation control requires first that the soil surface is protected from the erosive forces of wind, rain, and runoff, and second that eroded soil is captured on-site. Erosion control is the prevention or minimization of soil erosion. Sediment control is the trapping of suspended soil particles. Erosion control is the preferred approach. Sediment control is necessary because some erosion is unavoidable. The following principles are not complex but

are effective. They should be integrated into a system of control measures and management techniques to control erosion and prevent off-site sedimentation.

***Fit site construction to the terrain.*** Review and consider all existing conditions in the initial site selection for the project. When construction is tailored to the natural contours of the land, little grading is necessary and erosion potential is consequently reduced.

***Time grading and construction to minimize soil exposure.*** Scheduling can be a very effective means of reducing the hazards of erosion. Stage construction activities to minimize the exposed area and the duration of exposure. In scheduling, take into account the season and the weather forecast. Time grading to coincide with a dry season or a period of lower erosion potential. Stabilize disturbed areas as quickly as possible.

***Retain existing vegetation whenever feasible.*** Vegetation is the most effective form of erosion control. Very little erosion occurs on a soil covered with undisturbed natural vegetation. Reestablishing vegetation can be a difficult and costly process. If possible, strip only the area where construction will actually occur, street and driveway lines, and cut and fill slopes. Try to integrate existing trees and other natural vegetation into the site improvement plan.

***Vegetate and mulch denuded areas.*** Seed and mulch denuded soils as soon as possible after grading is completed. Mulch helps seedlings to become established and protects the soil from raindrop splash until vegetation takes over. Soils may be planted with temporary or permanent vegetation. If the soil will be exposed during the winter months, protective measures other than vegetation must be used.

***Divert runoff away from denuded areas.*** When vegetative cover is removed from land, the soil becomes highly susceptible to erosion. Runoff from areas that have been denuded should not be allowed to cross the exposed soils, particularly when the denuded areas are on slopes. Use diversion dikes or swales to divert upland runoff away from a disturbed area to a stable outlet.

***Minimize length and steepness of slopes.*** Slope length and steepness are among the most critical factors in determining erosion potential. Increasing slope length and steepness increases the velocity of runoff, which greatly increases its erosive energy. If slope steepness is doubled while other factors are held constant, soil loss potential is increased 2-1/2 times. If both slope steepness and length are doubled, soil loss potential is nearly 4 times greater. To prevent erosive velocities from occurring on long, steep slopes, interrupt the slopes at regular intervals using barrier or trap techniques.

***Keep runoff velocities low.*** The energy of flowing water increases as the square of the velocity, that is, as the velocity doubles, the erosive energy will quadruple and the water can theoretically move particles 64 times larger by volume. Channel velocities can be kept low by lining drainage ways with rough surfaces such as vegetation and riprap, by designing broad, shallow flow areas, and by constructing check dams at frequent intervals. Concrete channels, although efficient and easy to maintain, remove runoff quickly, often resulting in downstream channel erosion and flooding.

***Prepare drainage ways and outlets to handle concentrated or increased runoff.*** Construction changes the characteristics of runoff. The creation of impervious surfaces, removal of plant

cover, and compaction of soil by construction traffic allows less water to percolate into the soil and therefore increases the volume of runoff. Alternatively, if a project can be so designed that runoff from development areas is allowed to infiltrate into the soil on-site, no off-site channel enlargement or protection should be necessary. To prevent channel erosion from occurring, design drainage ways to withstand the peak flows without erosion, select lining materials appropriate for peak flows, and de-energize concentrated flows at outlets using energy dissipaters.

***Trap sediment on site.*** If development substantially changes the natural drainage conditions in a watershed, merely protecting the drainage channels on a project site may not be sufficient to prevent erosion. Some erosion during construction is unavoidable. The function of a sediment barrier is to prevent sediment from leaving a site after the soil has been eroded from its place of origin. Sediment laden runoff should be detained on-site so that the soil particles can settle out before the runoff enters receiving waters. Locate sediment basins and traps at low points below disturbed areas. Use earth dikes or swales to route drainage from disturbed areas into the basins. Sediment barriers and sediment fences can be placed below small - disturbed areas on gentle to moderate slopes. Storm water temporarily ponds up behind these barriers, allowing sediment to settle out.

***Inspect and maintain control measures.*** Inspection and maintenance of control measures are vital to the success of an erosion and sediment control program. Most control measures require regular maintenance. Problems often develop during a single storm. Some problems left untreated can result in more erosion damage than might have occurred without any erosion control measures. Inspect control measures frequently, particularly before, during, and after storm events, to ensure that they are working properly. Correct problems as soon as they develop. Assign to an individual the responsibility for routine inspections of operating erosion and sedimentation control practices.

### 3.2 Five Basic Rules of Planning

Successful erosion control requires minimizing disturbed areas therefore an ESCP should emphasize scheduling and phasing. Project scheduling and phasing is often driven by factors other than erosion control, so contingency planning is essential. Most importantly, the ESCP should be designed and implemented as a living, dynamic plan that can be adapted to address changes in the project as work progresses.

Erosion control measures are required for construction areas where the ground surface will be disturbed by clearing, grading, fills, excavations and other construction activities. When developing an effective ESCP, there are several important concepts to consider:

- Timing - schedule work to minimize overall impacts
- Stage work - identify & process critical areas first
- Minimize disturbance – retain vegetation, create buffers & reduce mass grading
- Pre-construction meetings - during preliminary design & prior to on site grading activities
- Pictures/Video - documentation throughout life of project

Another important concept to keep in mind when developing erosion sediment control plans is that implementing construction practices, which minimize the amount of disturbed land area and avoids or minimizes work on steep slopes, can lead to positive results. For example:

- There is less chance of soil washing off the site onto streets, drainage systems, and adjacent properties.
- Existing water quality facilities are protected by reducing impacts from disturbance activities.
- The number and size of erosion control measures required will be minimized.
- The overall cost of maintaining erosion and sediment control facilities are minimized.
- Top soil is retained on the site, making revegetation and landscaping easier to re-establish.

It is equally important to note that approval of an erosion and sediment control plan by the local jurisdiction does not relieve the applicant's responsibility to ensure that erosion control measures are constructed and maintained to prevent sediment from leaving the construction site. These requirements are upheld throughout the life of the construction site.

### **3.3 Designer Responsibilities & Designated Persons**

A designer puts the ESCP together based upon information obtained from local and regional agencies, and a detailed field site visit. In addition, the designer must, identify potential erosion and sediment problems, develop design objectives, formulate and evaluate alternatives, select the best erosion prevention measures, and develop a clear plan. A determination is made about what best management practices are appropriate. A variety of BMPs should be included on the plan in order to provide adequate tools in the field. By following the step-by-step process listed in Section 3.6, designers can improve overall success.

The designated person, whether contractor or erosion and sediment control specialist, has a defined responsibility to prevent pollution from leaving the site. The person must follow the approved ESCP, and ensure that the site is stable. Even though the ESCP may be followed in detail and appear to have addressed all issues, there will inevitably be obstacles along the way that will require the approved plan be revised. The ESCP must be accurate and reflect existing site conditions. The best scenario includes a good plan, open lines of communication, and defined responsibilities.

For 1200-C permits, the designated person is responsible for monitoring and record keeping of the site conditions as they relate to erosion prevention and sediment control. For projects that are five or more acres, inspections must be conducted by a person certified in an approved erosion and sediment control program. In addition to having appropriate training and experience, the DEQ 1200-C Guidance specifies that the designated person:

- is knowledgeable in the principles and practice of erosion and sediment controls,
- possesses the skills to assess conditions at the construction site that could impact stormwater quality,
- is knowledgeable in the correct installation of the erosion and sediment controls, and
- is able to assess the effectiveness of any sediment and erosion control measures selected to control the quality of stormwater discharges from the construction activity

### 3.4 Planning Resources

When determining what erosion prevention measures are appropriate for a particular site, it is important to utilizing the best available information. Several resources are available that can inform designers during development of the ESCP and lead to the correct decisions on what BMPs are needed to keep a construction site stable.

#### 3.4.1 Soil Survey Information

Knowing the type of soil found on the project site will help the designer decide upon the degree of erosion protection required. This will ensure that the ESCP is adequate to control soil movement without being overly conservative. Each county has a published survey of soils and that information is found in the Natural Resource Conservation Service Soil Survey, a mapped inventory by county with physical properties and characteristics described for each soil type.

Of prime importance are the predictions of soil behavior for selected land uses. Great differences in soil properties can occur even within short distances. Soils may be seasonally wet or subject to flooding. They may be shallow to bedrock. A directory of NRCS county offices can be found on the Internet at <https://www.nrcs.usda.gov/wps/portal/nrcs/site/national/home/>

#### 3.4.2 Environmental Data

The designer should determine if there are sensitive areas or natural resources that will require protection. State and federal regulatory agencies such as Department of State Lands and the US Army Corps of Engineers and local jurisdictions will have available data that shows the location of protected waterways or natural areas that will need to be taken into consideration when developing the ESCP.

#### 3.4.3 Climate and Precipitation Data

The occurrence and amounts of rainfall is important for the designer when deciding to what extent the erosion control measures must be used. Rain gauges can be used to assist in determining on-site rainfall. Precipitation data may be found by visiting the National Weather Service website at <https://www.weather.gov/>

West Coast Weather Observation at <https://www.weather-forecast.com/topographic-maps/west-coast> gives information on temperatures, wind direction, relative humidity, and precipitation all over Oregon. Oregon Coast and Pacific Northwest Weather Forecasts, provides weather predictions as well as current weather data and can be found at <https://graphical.weather.gov/sectors/pacnorthwest.php>

#### 3.4.4 Topography

From the site visit, determine the drainage patterns from the topography. Does runoff flow from offsite through the construction site? If so, measures should be taken to re-route this water around areas that will have ground disturbance.

Will areas of soil disturbance occur on long or steep slopes? If so, the lengths of the uninterrupted flows should be broken up so that the rainfall runoff will only flow short distances thereby decreasing flow velocity and the erosive force. In flat areas, runoff is slow and soil particles are not moved far from the point of raindrop impact. If the slopes are steep and short, surface cover may be needed to decrease runoff and promote rainfall infiltration into the soil. On steep slopes, soil movement increases dramatically. Constructing on very long slopes and especially, long, steep slopes should be avoided. Those that already exist should not be disturbed.

The Department of Geology and Mineral Industries (DOGAMI) helps increase understanding of Oregon's geologic resources and hazards and has publications that are available free of charge, and can be download at <https://www.oregongeology.org/pubs/pubsearch.htm>. The U.S. Geological Survey has also published Oregon information, which is available at <https://pubs.er.usgs.gov/>

### 3.4.5 Revised Universal Soil Loss Equation (RUSLE)

In order to properly design detention and conveyance structures, a designer must be able to calculate the quantities of water and sediment that will need to be managed by the structure. The design method for calculating soil loss from disturbed land is the Revised Universal Soil Loss Equation (RUSLE). RUSLE estimates soil loss from a slope caused by raindrop impact and overland flow (collectively referred to as "interrill" erosion), plus rill erosion. It does not estimate gully or stream-channel erosion. RUSLE is a tool to estimate the rate of soil loss based on site-specific environmental conditions and a guide for the selection and design of sediment and erosion control systems for the site. RUSLE does not determine when soil loss is excessive at a site, when erosion control systems have failed, or sediment yield once it has left the site. The RUSLE user makes such decisions based upon numerous criteria, of which soil-loss and sediment-yield estimates are an important compound.

The RUSLE formula can be found in this manual on page 3-10 under step 6. For a complete copy of the guidelines and the public domain RUSLE software, please visit: [http://fargo.nserl.purdue.edu/rusle2\\_dataweb/RUSLE2\\_Index.htm](http://fargo.nserl.purdue.edu/rusle2_dataweb/RUSLE2_Index.htm)

### 3.4.6 Agency Contact Information

- Check the website of the local jurisdiction that your project will be in to ensure that you have the most current information on their erosion prevention and sediment control requirements.
- Oregon Seed Certification Service <https://seedcert.oregonstate.edu/>
- Natural Resource Conservation Service <https://www.nrcs.usda.gov/wps/portal/nrcs/site/or/home/>
- International Erosion Control Assoc. [www.ieca.org](http://www.ieca.org)
- National Weather Service [www.weather.gov](http://www.weather.gov)
- PNW IECA [http://www.ieca.org/IECA/IECA\\_Events/Chapter\\_Events/individual\\_pages/Pacific\\_Northwest\\_Chapter.aspx](http://www.ieca.org/IECA/IECA_Events/Chapter_Events/individual_pages/Pacific_Northwest_Chapter.aspx)
- West Coast Weather Observations <https://www.weather-forecast.com/topographic-maps/west-coast>
- Oregon Coast and Pacific NW Weather <https://graphical.weather.gov/sectors/pacnorthwest.php>
- US Army Corps of Engineers (COE) <http://www.usace.army.mil/>
- Dept. Of State Lands (DSL) <http://www.oregon.gov/DSL/>
- OR Dept Of Fish & Wildlife (ODFW) <http://www.dfw.state.or.us/>
- ODEQ <https://www.oregon.gov/deq/wq/wqpermits/Pages/Stormwater-Construction.aspx>
- OR Dept. of Agriculture (ODA) <http://oregon.gov/ODA/>
- OR Dept of Transportation (ODOT) <http://oregon.gov/ODOT>
- DOGAMI <https://www.oregongeology.org/>

### 3.5 Project Scheduling

Following a specified work schedule that coordinates the timing and land disturbing activities and the installation of control measures is perhaps the most cost-effective way of controlling erosion during construction. The removal of ground cover leaves a site vulnerable to accelerated erosion. Construction procedures that limit land clearing, provide the timely installation of erosion control and sedimentation controls, and restore protective cover quickly can significantly reduce the erosion potential of a site.

Construction projects should be phased to reduce the amount and duration of soil exposure to erosion by wind, rain, runoff, and vehicle tracking. The construction schedule is an orderly listing of all major land disturbing activities together with the necessary erosion and sedimentation control measures planned for a project. This type of schedule guides the contractor on work sequencing so that serious erosion and sedimentation problems can be avoided.

The ESCP should indicate in each of the scheduled work activities, how the proposed erosion/sediment control measures will divert flows, limit runoff from exposed areas, stabilize exposed soil and filter sediment. The following activities should be included in the schedule, if applicable.

- Obtain approval of EPSC plan and permits
- Clearing and grubbing for perimeter controls only
- Installation of perimeter controls
- Installation of site drainage measures if called for in ESCP
- Inspection and approval of measures per plan
- Construction phasing
- Clearing and grubbing, grading and trenching for activities other than perimeter control.
- Grading (including off-site activities) related to the project.
- Final grading, landscaping, and stabilization.
- Work on or at bridges and other water course structures.
- Utility installation and removal.
- Work required in any wetland.
- Monitoring and recording of rainfall.
- Inspection of controls.
- Installation and maintenance of permanent controls.
- Long-term establishment of permanent soil stabilization
- Disposal of waste materials generated on-site
- Installation, maintenance and removal of temporary controls.
- Keep inspection logs current.

Note that the construction activities listed above do not usually occur in a specified linear sequence, and schedules will vary due to weather and other unpredictable factors.

Schedules for temporary and permanent erosion control work is required in any wetlands or watercourse. Plans showing proposed clearing work such as grubbing, grading, trenching, bridges, construction, and paving should be submitted to the appropriate Agency for review. In addition, plans for erosion control on haul roads and borrow pits and plans for disposal of waste materials should be submitted. The contractor may submit the ESCP from the project plans if it is correct for the proposed stage of construction, or prepare a modified version, proposing methods, materials, and procedures, to be used for the weather and site conditions at the time of construction, if applicable.

### 3.6 Developing an Erosion and Sediment Control Plan

The following are recommended steps that can be use in the development and implementation of an acceptable Erosion and Sediment Control Plan. This information will provide the necessary tools to gain jurisdictional approval and reduce overall environmental risks. Once the project site has been assessed, the catch points for cuts and fills, drainage areas and drainage patterns, sensitive areas, size and location of drainage structures, and of disturbance should be located on the base map. Approximate final grades and any known problems such as highly erodible soils or unstable slopes should also be noted. A sample ESCP and details can be found in Appendix A.

#### *Step 1: Identify Potential Issues*

- Public opinion
- Environmental interest groups
- Public Agencies
- Federal and State Environmental Regulations

#### *Step 2: Goals and Objectives*

- Meet all regulations
- Minimize negative public opinion
- Improve aesthetics
- Enhance the environment
- Decrease liability
- Higher emphasis on stabilizing steep slopes (2:1 or greater)
- Reduce short and long term erosion
- Reduce or eliminate irrigation costs
- Maximize use of on-site materials (cost-effective solutions)
- Reduce overall maintenance

#### *Step 3: Erosion Study*

- Sediment sources
- Review relative sources
  - Maps and aerial photos
  - Distinctive minerals
  - Alluvial fans
- Review regional factors
  - Temperature
  - Precipitation
  - Wind
  - Freeze/thaw
  - Snow melt



- Review watershed
  - Watershed size
  - Topography
  - Channel density
  - Soil types
  - Ground cover
  - Land use

### *Step 4: Selection of Erosion and Sediment Control Materials*

- Effectiveness
- Environmental impacts
- Regulatory acceptability
- Material Cost
- Long-term cost (maintenance)
- Public acceptability
- Risk/liability
- Aesthetics

### *Step 5: Developing the ESCP (where to go?)*

- Local planning and zoning department
  - Regulations and ordinances
  - Prior land use
  - Adjacent and downstream uses
  - Site information
- NRCS/District Conservationist
  - Soils
  - Climate
  - Vegetation/habitat
  - Water management
  - Recreational potential
  - Aerial surveys
- U.S. Geological Survey
  - Topographical maps
  - Major drainage ways
- State Environmental Agencies
  - Stream surveys
  - Wildlife habitat
  - ESA
  - Wetlands
  - Sensitive areas
- Local Flood Control
  - Rainfall data
  - Storm records
  - Flood plains

### *Step 6: Developing the ESCP (collecting data)*

- Photo/video documentation
- Field survey and evaluation (existing)
  - Topography & contours
  - Existing drainage upstream & downstream
  - Identify sensitive areas
  - Soil samples
  - Soil survey (NRSC)
- Field survey and evaluation (future)
  - Topography & contour design
  - Site drainage system type & location
  - Impervious areas
- Climate and rainfall information
  - Onsite rain gauges
  - Meteorologists
  - Airport
- Critical habitat
  - Wetlands vegetation profile
  - Mitigation/enhancement
- Revised Universal Soil Loss Equation (RUSLE)
  - $A = R \times K \times LS \times C \times P$
  - A = Average annual rate of erosion in tons/ac/yr
  - R = Rainfall factor
  - K = Soil erodibility factor
  - L = Slope length
  - S = Slope gradient
  - C = Cover
  - P = Conservation practice

### *Step 7: Lay out Pre-construction Plan & Base Measures*

- Adapt the plan to the resources available
- Fit the development to the existing terrain whenever possible
- Plan must be flexible
- Keep communication lines open at all times
- All reports and instructions must be clear
- Determine construction timing and sequence
- Establish primary access point (s) for construction traffic
- Lay out limits of clearing & construction activities
- Restrict all activities in sensitive areas (mark accordingly)
- Establish base measures including sediment control at toe of disturbed area & stabilized construction entrances
- Establish maintenance procedures for EC Measures

### *Step 8: Identify Measures During Construction*

- Install additional base measures as site clearing/disturbances occur, including stockpiles & slope contours
- Determine if construction may occur during wet weather season (October 1<sup>st</sup> – May 31<sup>st</sup>)
- Establish & schedule wet weather measures including cover measures over exposed soils
- Continue to establish maintenance procedures for EPSC measures

### *Step 9: Post Construction Measures*

- Establish ground cover or permanent landscaping prior to removing base measures

### *Step 10: Plans and Specifications (Sample ESCP-Appendix A)*

- Project description
- Construction notes
- BMPs standard symbols (*see appendix A*)
- Names and locations of existing roads, waterways, and drainage features
- Boundaries of environmentally sensitive areas such as wetlands
- Right of way and easements
- Statement of existing conditions to include highly erodible areas (steep slopes)
- Existing and proposed contour lines
- Run-off calculations
- Calculations of desired performance standards
- Description of erosion control treatment areas
- Detailed grass establishment instructions
- Detail for each BMP used
- Wind erosion control during/following construction

### *Step 11: Operations and Maintenance*

- Guidelines
- Maintenance instructions
  - Provide operating procedures during/after storm events
- Standards of performance
- Periodic inspection reports w/supported pictures
- Vegetation criteria
- Monitoring
  - Establish procedures for monitoring performance
  - Provide adjustment to mitigation measures as needed
- Monitoring and maintenance plan
- Maps
  - Project boundaries
  - Adjacent areas
  - Existing and final topographic features
  - Drainage areas
  - Location of existing problems
  - Location of potential problems
  - Location and extent of BMPs

This page intentionally left blank.

## **CHAPTER 4**

### **EROSION AND SEDIMENT CONTROL MEASURES AND BMPs**

This chapter presents best management practices (BMPs) for erosion and sediment control. The BMPs described in this chapter represent commonly accepted practices that are used to prevent erosion and off site sedimentation during construction activities. Information such as advantages, disadvantages, design, inspection, and maintenance requirements for each BMP are included, and should help in choosing the most appropriate measure or control for given site conditions.

In order to maximize the overall benefits of any BMP selection and placement, there must be a thorough understanding of the site characteristics. The details of installation can and should vary in the field depending on the site conditions. Field variations for each type of measure may be needed during the life of the project. The substitution of other cost-effective products or methods that provide equivalent or superior in performance is encouraged but may need to be approved by state and local agencies.

As implied by their name, BMPs are stabilization methods and structural erosion control measures that if installed and maintained properly can be very effective. Table 4-1 represents commonly accepted practices and the effectiveness ratings for basic applications of each erosion and sediment control measure.

## CHAPTER 4: EROSION AND SEDIMENT CONTROL MEASURES AND BMPs

**Table 4-1** Matrix of temporary and permanent erosion control measures and estimated effectiveness ratings: E=Excellent, M=Moderate

BMP APPLICATION	TEMPORARY/ PERMANENT	RATING	PAGE
<b>EROSION PREVENTION</b>			
Buffer Zone	P	E	4-5
Preserve Natural Vegetation	P	E	4-7
Dust Control	T	M	4-11
Ground Cover	T	E	4-14
Hydraulic Applications	T/P	E	4-18
Matting	T	M	4-22
Plastic Sheeting	T	M	4-30
Seeding Temporary/Permanent	T/P	E	4-34
Sod	P	M	4-41
<b>RUNOFF CONTROL</b>			
Check Dams	T	M	4-44
Diversion Dikes and Swales	T	M	4-50
Grass-lined Swale	T	M	4-54
Outlet Protection	T	E	4-58
Pipe Slope Drain	T	E	4-63
Surface Roughening	T	E	4-69
<b>SEDIMENT CONTROL</b>			
Bio-filter Bags	T	M	4-77
Construction Entrance	T	E	4-80
Dewatering	T	E	4-84
Filter Berm	T	M	4-89
Inlet Protection	T	M	4-94
Oak Mats	T	E	4-104
Pre-Fabricated Barriers	T	M	4-108
Sand Bags	T	M	4-111
Sediment Basin	P	E	4-115
Sediment Fence	T	M	4-121
Sediment Trap	T	E	4-127
Sidewalk Subgrade Gravel Barrier	T	M	4-133
Tire Wash	T	E	4-138
Wattles	T	M	4-143

### 4.1 Erosion Prevention Best Management Practices

Erosion prevention is the most effective and inexpensive method for reducing overall environmental impacts associated with construction activities. With this in mind, timing, staging, and minimizing the amount of exposed soil and directing surface water runoff away from exposed soil are all excellent ways to minimize erosion during construction. Erosion prevention practices primarily involve preserving natural vegetation when possible or stabilizing exposed soils with temporary covers or permanent vegetation. Reducing the erosion associated with construction vehicular traffic is also covered in this section. Employing the following erosion prevention techniques can reduce erosion by 80 to 95 percent compared with exposed soils.

1. Buffer Zone
2. Preserve Natural Vegetation
3. Dust Control
4. Ground Cover
5. Hydraulic Applications
6. Matting
7. Plastic Sheeting
8. Seeding - Temporary and Permanent
9. Sod

This page intentionally left blank.



# BUFFER ZONE



### 4.1.1 Buffer Zone

A buffer zone consists of an undisturbed area or strip of natural vegetation adjacent to a disturbed area that reduces erosion and runoff. This zone should not be confused with the “Natural Buffer Zone” requirement found in the ODEQ 1200-C permit. The buffer zone should not be used as a sediment control measure.

#### Advantages

- Filters sediment.
- Promotes infiltration.
- Provides habitat.
- Reduces velocity and quantity of runoff, dissipates energy.
- Provides visual screening.
- Can be used to stabilize stream banks.
- Low maintenance.

#### Disadvantages

- Requires keeping all construction equipment, debris and soils out of the buffer zone.
- Extensive buffer zones can cover large areas of land that are not available for project development.

#### Design Criteria

- Preserve natural vegetation in clumps, blocks or strips.
- Preserve natural vegetation on unstable, steep slopes.
- Clearly establish construction limits with orange construction safety fence and signs spaced 100 feet apart. Perimeter sediment control should also be used to ensure protection of buffer zone.
- Vegetative buffer zones for streams, lakes or other waterways should meet current regulatory standards for required buffer width. Check with local jurisdiction for specific buffer zone requirements.
- The most common problem with this BMP is non-observance of clearing limits and clearing of the entire site prior to construction. If possible, work with the contractor to establish a phased clearing and grading schedule at the beginning of the project.

#### Inspection & Maintenance

- Inspect flagging and fencing frequently and repair as needed.

# PRESERVE NATURAL VEGETATION



### 4.1.2 Preserve Natural Vegetation

This BMP involves preserving natural vegetation to the greatest extent possible during the construction process, and after construction where appropriate. Maintaining as much natural vegetation within the perimeter of the project site is the most effective and inexpensive form of erosion prevention control. This method is particularly important in helping to protect sensitive areas such as wetlands, stream corridors, lakes, and near steep slopes. The project manager, inspector and contractor should address and discuss preserving natural vegetation during the Pre-construction meeting. Although this is a proven BMP, it is imperative that all exposed soils are covered in a timely manner.

#### Advantages

- Helps reduce soil erosion and runoff.
- Saves landscaping costs, provides areas for wildlife, and provides visual screening.
- Retains existing shade and cover habitat.

#### Disadvantages

- Retaining existing trees could create a safety hazard. If considering removing trees due to hazard concerns ensure these trees are not shown on the site plan as needing to be retained.
- May constrict area available for construction activities.

#### Design Criteria

- Coordinate with the Landscape Architect and Environmental Professionals assigned to the project when determining what to save and how to save it.
- Vegetation can be preserved in natural clumps or as individual trees, shrubs and vines.
- Clearly establish and mark ground disturbance limits outside the dripline of preserved trees, using orange construction safety fence or flagging if approved.
- Protect vegetation from:
  - Construction equipment injury above or below the ground level. Injury can occur from scarring, cutting roots, or compaction.
  - Grade changes, which affect the plants' ability to obtain air, water or minerals. Placing a layer of gravel and a tile system over the roots before a major fill allows air to circulate and protects the plant from the fill.

## **CHAPTER 4: EROSION AND SEDIMENT CONTROL MEASURES AND BMPs**

---

- Terracing the area around the plant, or leaving the plants on an undisturbed mound can increase the plants' survival chances. Will protect against excavations for utilities and cover exposed roots.

### Inspection & Maintenance

- Repair and/or replace damaged fencing.
- Evaluate the condition of the vegetation to ensure it continues to protect against erosion.
- Re-cover and protect exposed plant roots.

This page intentionally left blank.

# DUST CONTROL



### 4.1.3 Dust Control

Preventative measures to minimize the wind transport of soil and to reduce dust generated by construction activities.

#### Advantages

- Reduces movement of soil to offsite areas.
- Increases visibility.
- Prevents traffic hazards.
- Reduces sediment transported by wind and deposited in water resources.

#### Disadvantages

- Over watering may cause erosion and tracking.
- Most methods require immediate reapplication if disturbed.
- Too little watering fails to control dust.

#### Design Criteria

- Schedule construction operations so that the least amount of project area is disturbed at one time.
- Apply water over areas that are susceptible to wind erosion or applying other soil-binding palliatives.
- Install construction entrances and stabilizing construction haul roads with crushed rock
- Install temporary or permanent surface stabilization measures immediately after completing land grading. Measures include:
  - Seeding
  - Mulching
  - Matting
  - Tackifier
  - Chemical Soil Stabilizers
- Covering stockpiles will reduce potential for wind to release dust.

#### Inspection & Maintenance

- Maintain dust control measures through dry weather periods until all disturbed areas have been stabilized.
- Immediately re-stabilize areas disturbed by contractor's operations or other activities.



This page intentionally left blank.

# GROUND COVER



### 4.1.4 Ground Cover

Ground cover is a protective layer of straw, mulch or other suitable material applied to the soil surface that provides immediate temporary protection from erosion. Ground cover can be applied manually or by machine. In some cases, straw mulch and/or hydromulch can be used in conjunction with seeding for the establishment of temporary or permanent vegetation in disturbed areas. Mulch also enhances plant establishment by conserving moisture, holding fertilizer, seed, and topsoil in place, and moderating soil temperatures.

#### Advantages

- Provides immediate protection.
- Conserves moisture
- Acts as a thermal layer for seed
- If used in conjunction with seed, allows seed growth through the mulch
- Protects seeding from direct heat, moisture loss and transport due to runoff
- Used for dust control

#### Disadvantages

- Thick mulches can delay germination.
- Can be blown or washed away if not correctly applied.
- Must be removed prior to applying fill material.

#### Design Criteria

- Divert concentrated runoff away from areas to be covered.
- Refer to Table 4-2, which outlines ground cover type, quality, and application rate.
- Refer to **Appendix C** for *Mulch and Seed Application Rate Worksheet*.
- Additional measures may be required to improve effectiveness on slopes.
- On sites where chopped straw is applied, the straw needs to be anchored using a liquid tacking agent.
- The straw mulch should not be moldy, caked, decayed or of otherwise low quality. May be required to submit verification from the supplier that the straw is free of noxious weeds. This verification is especially important when using straw mulch near natural areas.

#### Inspection & Maintenance

- Maintain specified thickness of the cover. See Table 4-2
- Re-cover and/or protect with a net or blanket any areas that experience erosion. If the erosion problem is drainage related, fix the drainage problem first and re-cover

## CHAPTER 4: EROSION AND SEDIMENT CONTROL MEASURES AND BMPs

---

the eroded area. If mulched areas are damaged by concentrated runoff and erosion is evident, prompt implementation of additional practices and BMPs may be necessary.

- Hydraulically treated areas shall be inspected and monitored after installation and periodically thereafter.
- Hydraulic mulches and tackifiers are interim measures until the permanent erosion-resistant cover is established. If the hydraulic mulch or tackifiers were applied as stand alone (without vegetation) treatments for erosion and dust control, the product longevity must match the length of time that the soil will remain bare or until revegetation occurs. Periodic inspections will assure the intended purposes will be met.
- Areas that fail to establish cover adequate to prevent erosion should be re-covered as soon as such areas are identified.

## CHAPTER 4: EROSION AND SEDIMENT CONTROL MEASURES AND BMPs

**Table: 4-2 Ground Cover Application**

<b>Material</b>	<b>Quality Standards</b>	<b>Application Rate Per acre</b>	<b>Depth of Material</b>	<b>Considerations</b>
Straw	Air dried, free from unwanted seeds & coarse materials	2-2 ½ tons	2 inches min. uniform spread	Use where the mulching effects is to be maintained < 3 months. When chopped straw is applied, use a tackifier or stamped in.
Yard Debris Compost	Well composted organic matter free of metals, plastics and other foreign matter	3-6 tons	1 inch 4:1 slopes 2 inch 3:1 slopes 3 inch 2:1 slopes	Excellent soil amendment. Compost size: ¾ x 0 on 3:1 slopes or less. 1 ½ x 0 on 2:1 slopes.
Wood or Cellulose fiber	Dyed green, should not contain growth inhibiting factors	2000 lbs.	N/A	Apply with hydromulcher. May need to double the rate depending on soil and slope. Use tackifier as recommended by manufacturer.
Wood Chips or Grindings	Green or air-dried free of objectionable coarse materials	5-6 tons	1-3 inches depending on slope	Very durable. Apply with mulch blower, excavation equipment, or by hand. Not suitable for areas that require close mowing.
Gravel or Crushed Rock	Washed ¾- 1 ½ inch	9yds/1000 ft <sup>2</sup>	3 inches	Excellent for short slopes and where subject to foot traffic. Larger pit-run can be used on steep slopes prone to sub-surface water (springs).

# HYDRAULIC APPLICATIONS



### 4.1.5 Hydraulic Application

Hydraulic application is a mechanical method of applying erosion control materials to bare soil in order to establish erosion-resistant vegetation on disturbed areas and critical slopes. By using hydraulic equipment, ground covers such as, soil amendments, mulch, tackifying agents, Bonded Fiber Matrix (BFM) and liquid co-polymers can be uniformly broadcast, as homogenous slurry, onto the soil. These erosion and dust control materials can often be applied in one operation.

#### Advantages

- Provides rapid installation. Seed, fertilizer, mulch, tackifier, soil amendments, Bonded Fiber Matrix, and chemical stabilization can be applied in a one-step procedure.
- Generally requires less seedbed preparation, the surface soil may be left irregular with large clods, stones, or rock outcropping exposed.
- Uniformly distributes seed and mulch material.
- Increases favorable conditions for quick germination and growth.
- Can be used effectively on steep slopes and other areas where access is limited and where mulch would be difficult to otherwise anchor
- Can be used in areas where soil stabilization, seeding, and mulching practices would result in unacceptable levels of ground disturbance.
- Can be used where site conditions, such as irregular soil surfaces, existing vegetation, and shallow soils preclude the installation of erosion mats.
- Can be used for dust control.

#### Disadvantages

- Generally more expensive than broadcast or drilling seed applications.
- Thick mulch applications can delay germination.
- Can be blown or washed away if not adequately tackified.
- Required application rates can vary significantly dependent on site preparation.
- Application during wet weather can be difficult.

#### Design Criteria

- Divert concentrated runoff from above treated areas.
- Wood fiber mulch or wood/paper mulch should be applied at a rate of 2000 to 2500 lbs per acre.
- Bonded Fiber Matrix (BFM) is considered a liquid blanket and can be applied on steep 1:1 slopes at application rates between 3000 and 4000 lbs per acre, depending upon soil type and irregularities.

## CHAPTER 4: EROSION AND SEDIMENT CONTROL MEASURES AND BMPs

---

- When seeding, maintain sufficient moisture level using permanent or temporary irrigation.
- On sites where straw mulch has been applied, the straw needs to be anchored using a liquid tacking agent.
- If the hydraulic mulch or tackifiers were applied as stand alone (without vegetation) treatments for erosion and dust control, the product longevity must match the length of time that the soil will remain bare or until re-vegetation occurs.
- Refer to **Appendix C** for Hydraulic Application Tables for seed and mulch.

### Inspection & Maintenance

- Re-mulch and protect with additional BMPs in any areas that experience erosion. If the erosion problem is drainage related, fix the drainage problem first then make necessary repairs.
- Hydraulic mulches and tackifiers shall provide the necessary erosion protection until permanent erosion-resistant cover is established. If sheet or rill erosion is evident then prompt re-application of treatments shall be necessary.
- Areas that fail to establish 80% healthy stand of grass cover to prevent erosion should be properly covered using one of the ground cover applications.



This page intentionally left blank.

# MATTING

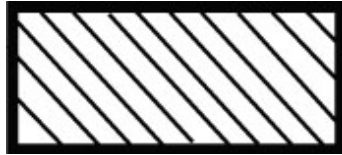

### 4.1.6 Matting

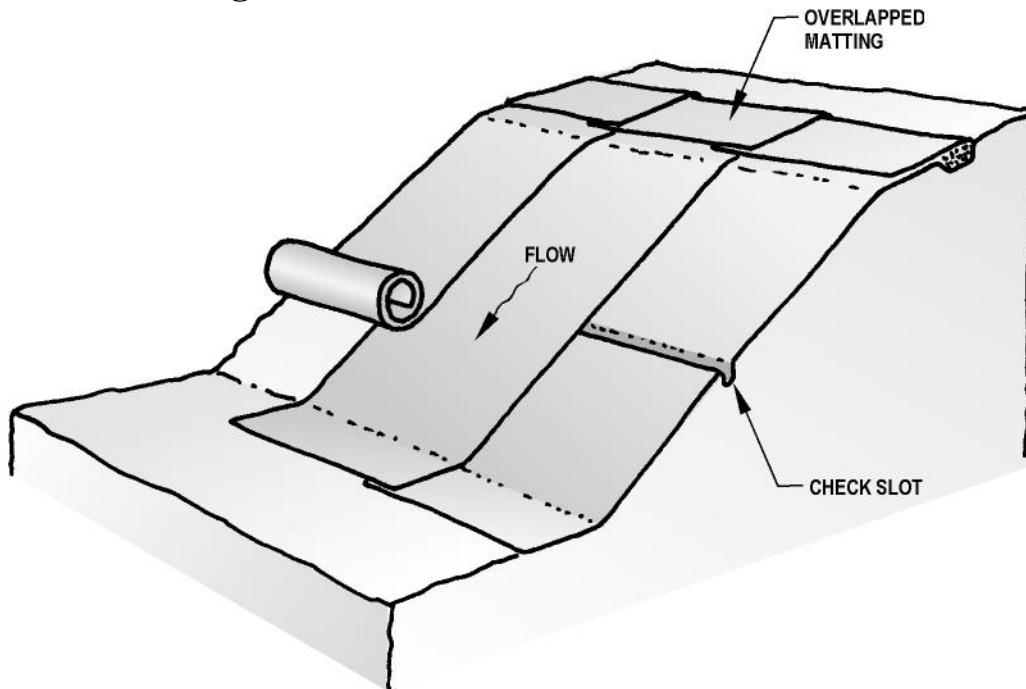

Matting is a class of products that are rolled, blanket-like materials used to stabilize and protect disturbed sloped areas. Matting can also be referred to as blankets, fabric and nets. A wide range of materials and combination of materials are used to produce matting including, but not limited to straw, jute, wood fiber, coir (coconut fiber), plastic netting, and Bonded Fiber Matrix. The selection of matting materials for a site can make a significant difference in the effectiveness of the BMP.

#### **When selecting matting consider these questions:**

1. How long will the matting be required to provide protection?
2. How steep is the slope?
3. What is the soil type?
4. What is the shear stress on the channel bottom?
5. Is the site within a natural area or sensitive area?

#### Advantages

- Immediate cushioning against splash erosion from raindrop impact.
- Does not generate high-velocity runoff and, therefore, offers temporary slope protection, which is superior to plastic sheeting.
- Captures a great deal of sediment due to its open, porous structure.
- Usually easy to install.

## CHAPTER 4: EROSION AND SEDIMENT CONTROL MEASURES AND BMPs

---

- Provides long-term protection, based on matting selection.

### Disadvantages

- Correct installation is critical to the effectiveness of these products. Good ground contact during installation prevents runoff concentrating under the blanket and causing significant erosion (tenting).
- Soil surface must be graded smooth with no surface irregularities.
- Limited protection capabilities when used as flexible channel liner.
- Synthetic mats made from non-biodegradable material may not be appropriate for placement in sensitive areas, due to the potential impact on wildlife.

### Design Criteria

- Generally used on slopes 2:1 and steeper.
- Surface must be graded smooth.
- Remove all debris and undulations larger than 2 inches in any dimension.
- Apply seed and fertilizer prior to matting.
- Install so that matting is in complete contact with soil surface.
- See **Table 4-3** for matting application and refer to manufacturer's specifications for staple pattern.
- Organic matting materials (excelsior, jute and coir) biodegrade and are useful for applications requiring stabilization for up to three months. Use organic blankets, which retain moisture and provide organic matter to the soil, for slope protection and short-term waterway protection and to improve the speed and success of revegetation.
- Excelsior brand (aspen wood fiber), woven straw, and coir (coconut fiber) blankets may be installed without mulch because they provide sufficient surface protection.
- Synthetic mats are made from non-biodegradable material and will remain in place for years and offers long-term stabilization (some photodegradation does occur). This matting option is not recommended for use near sensitive areas.
  - Turf Reinforcement Mats (TRM) are made from polymer netting or monofilaments formed into a Synthetic 3-D mat. TRMs protect seed and increase germination and acts as part of the root structure; giving the turf higher strength.
  - Erosion Control and Revegetation Mats (ECRM) are composed of heat-fused monofilaments or monofilaments stitched between netting and act as permanent mulch. ECRM allow growth through the mat.
- Channel or swale applications:
  - Lengthwise overlap: Min. 12 inches

## CHAPTER 4: EROSION AND SEDIMENT CONTROL MEASURES AND BMPs

---

- Crosswise overlap: Min. 6 inches
- Avoid joining material in center of ditch or swale
- Slope application:
  - Lengthwise overlap: Min. 6 inches
  - Crosswise overlap: Min. 6 inches
  - At top of slope, entrench matting material in a 6 inch X 6 inch trench and staple at 12 inch intervals
  - At bottom of slope, extend matting material 2 feet beyond the toe of the slope, turn material under 4 inches and staple at 12 inch intervals
  - On 4:1 slopes, rolls can be placed in horizontal strips
  - Matting material must be stapled in place as they are installed down the slope face every 4 feet until you reach the bottom. This keeps blanket in relaxed position, eliminating the potential for under-rilling.

### Inspection & Maintenance

- Repair any damaged areas of the matting material and staple into the ground any areas not in close contact with the ground surface.
- If erosion occurs, repair and protect the eroded area.

MATS/BLANKETS SHOULD BE INSTALLED VERTICALLY DOWNSLOPE.

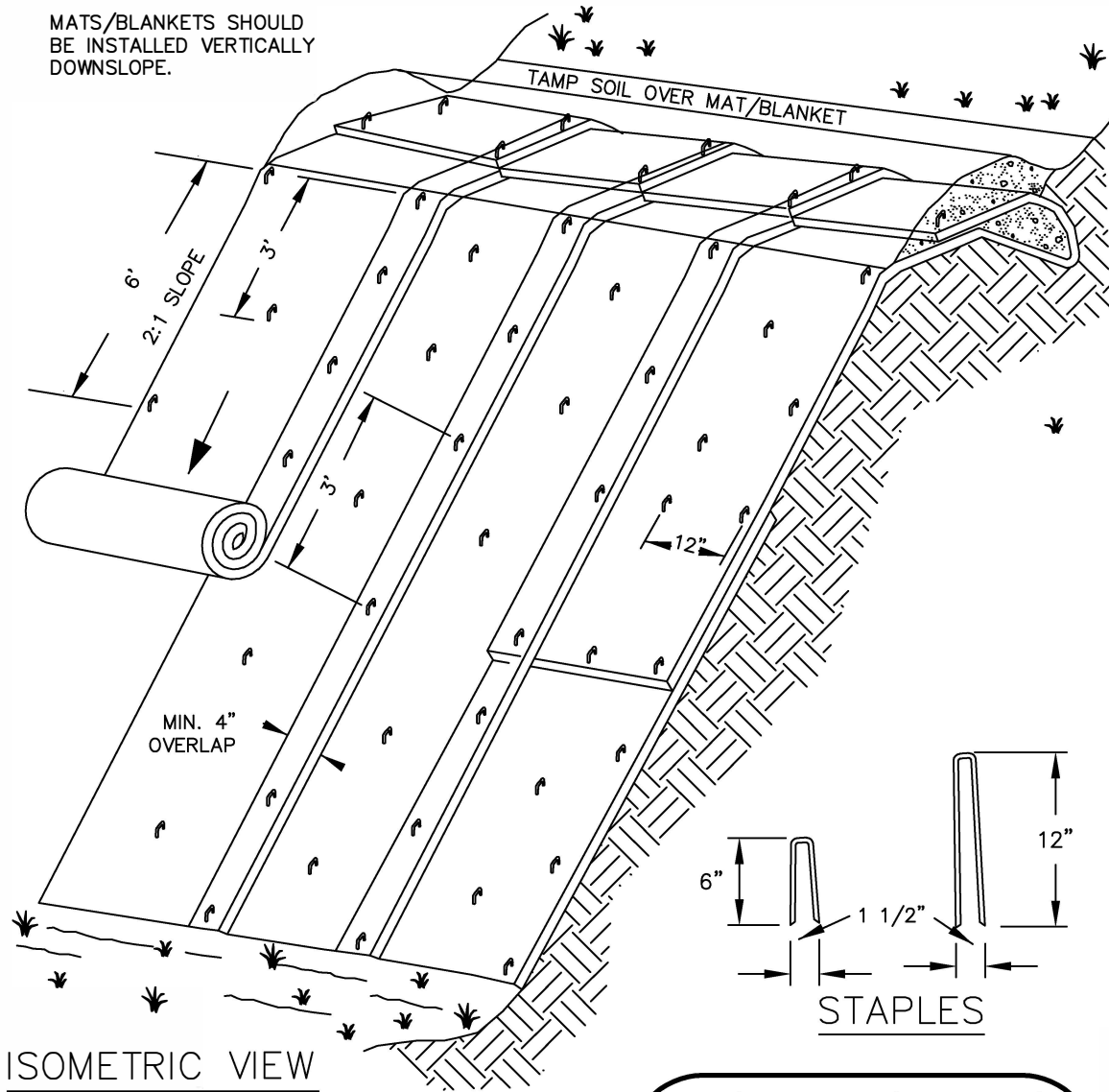

ISOMETRIC VIEW

TYPICAL SLOPE SOIL STABILIZATION

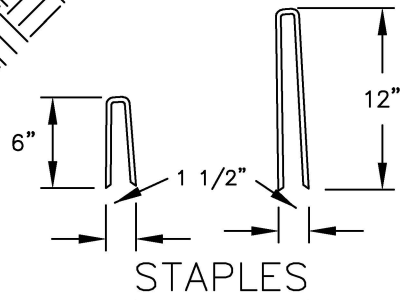

STAPLES

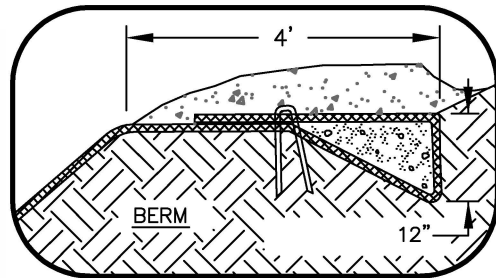

NOT TO SCALE

NOTES:

1. SLOPE SURFACE SHALL BE FREE OF ROCKS, CLODS, STICKS AND GRASS. MATS/BLANKETS SHALL HAVE GOOD SOIL CONTACT.
2. APPLY PERMANENT SEEDING BEFORE PLACING BLANKETS.
3. LAY BLANKETS LOOSELY AND STAKE OR STAPLE TO MAINTAIN DIRECT CONTACT WITH THE SOIL. DO NOT STRETCH.
4. STAKING OR STAPLING LAYOUT PER MANUFACTURERS SPECIFICATIONS.

MATTING SLOPE INSTALLATION

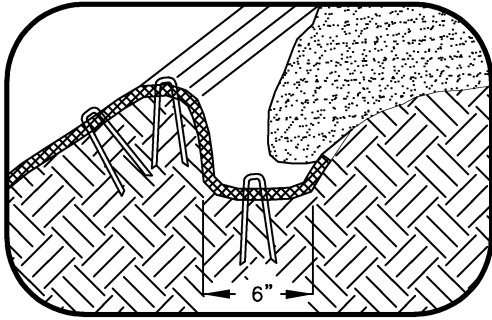

LONGITUDINAL  
ANCHOR TRENCH

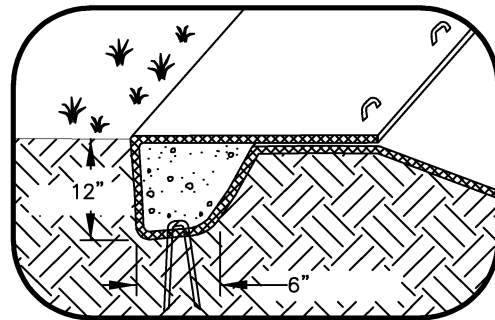

TERMINAL SLOPE AND  
CHANNEL ANCHOR TRENCH

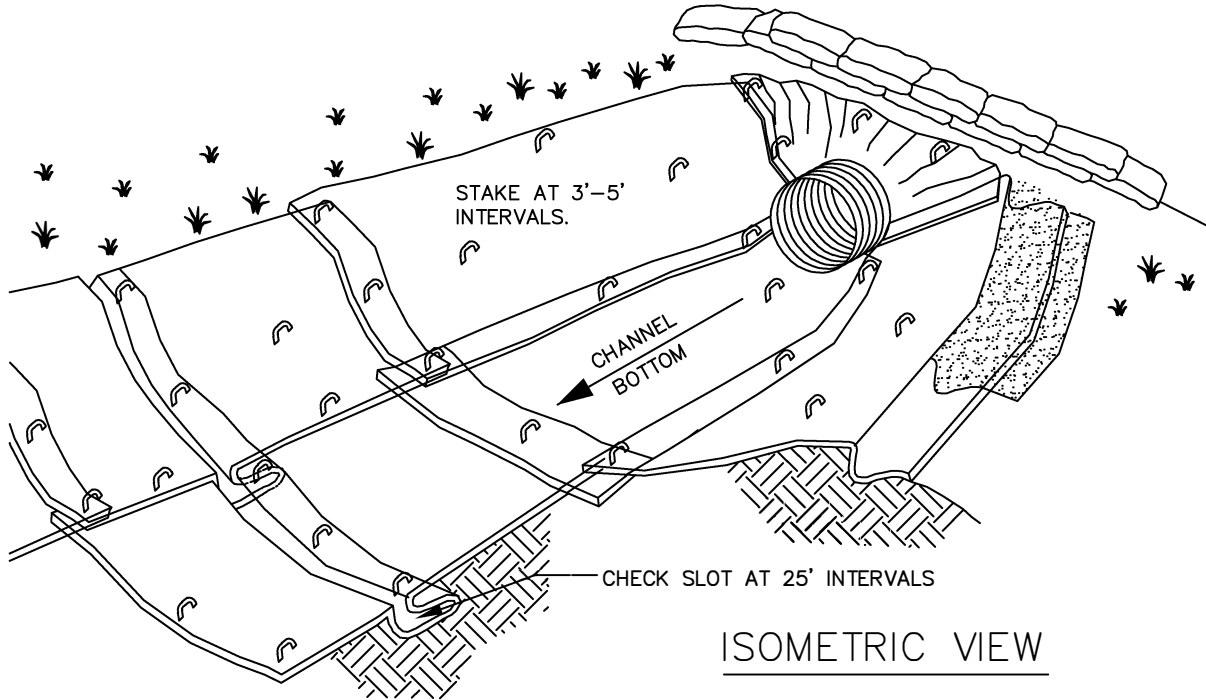

ISOMETRIC VIEW

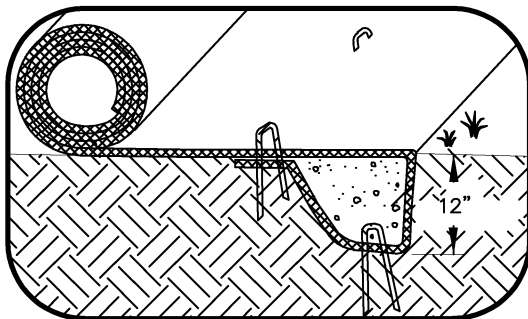

INITIAL CHANNEL  
ANCHOR TRENCH

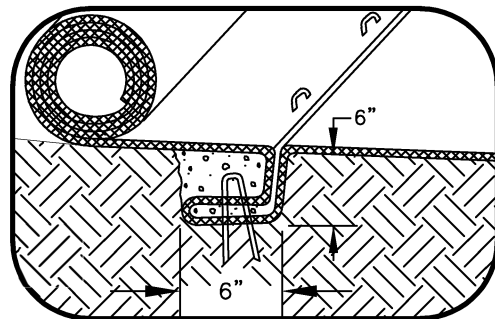

INTERMITTENT CHECK  
SLOT

NOTES:

1. CHECK SLOTS TO BE CONSTRUCTED PER MANUFACTURERS SPECIFICATIONS.
2. STAKING OR STAPLING LAYOUT PER MANUFACTURERS SPECIFICATIONS.

# MATTING CHANNEL INSTALLATION

## CHAPTER 4: EROSION AND SEDIMENT CONTROL MEASURES AND BMPs

**Table 4-3 Matting Specifications**

Matting Type	Slope/Channel Application	Netting Type
Straw	3:1 or less	Type 1 - Photo degradable polypropylene top/bottom Type 2 - 100% Bio degradable (used near sensitive habitat areas)
Straw/Coconut	2:1 or less	Type 1 – Photo degradable polypropylene top/bottom Type 2 – 100% Bio degradable (used near sensitive habitat areas)
Coconut	1:1 or less Low flow channels	Type 1 – Photo degradable polypropylene top/bottom Type 2 – 100% Bio degradable (used near sensitive habitat areas)
Jute	3:1 or less Short, 2:1 slopes	100% Bio degradable
Excelsior	2:1 or less Low flow channel	Photo degradable extruded plastic mesh top/bottom
Coir fabric	1:1 or less 8-10 fps channel	Type 1 – 1 inch grid 100% Bio degradable (4-10 year life) Type 2 – ½ inch grid 100% Bio degradable (4-10 year life) Type 3 – ¼ inch grid 100% Bio degradable (4-10 year life)
TRM	High flow channels 8-20 fps	Three dimensional synthetic polyolefin fibers mechanically bonded between two nets (not recommended for use near natural areas)



This page intentionally left blank.

# PLASTIC SHEETING



### 4.1.7 Plastic Sheeting

Provides immediate protection to slopes and stockpiles. Plastic sheeting has been known to transfer erosion problems because water will sheet flow off the plastic at high velocity. This is usually attributable to poor application, installation and maintenance. Use alternatives to plastic covering whenever possible.

#### Advantages

- Provides immediate, short-term erosion protection to slopes that are prone to erosion and stockpiles.
- Fairly quick and easy to install.

#### Disadvantages

- Plastic sheeting may concentrate sunrays and burn the vegetation beneath it.
- Smooth plastic sheeting can generate high velocity runoff.
- Plastic breaks down quickly when exposed to ultraviolet radiation.
- Plastic, when it is not removed, can clog drainage system inlets and outlets.
- If not properly anchored, wind may transport plastic.

#### Design Criteria

- Do not use plastic covering upslope of areas such as steep and/or unstable slopes that might be adversely affected by concentrated runoff.
- When possible, install an interceptor dike and/or pipe slope drain at the top of the plastic to divert flows away from the plastic.
- Toe-in the top of the sheeting in a 6 inch X 6 inch trench backfilled with compacted native material.
- Install a gravel berm, riprap, or other suitable protection at the toe of slope in order to dissipate runoff velocity.
- Anchor the plastic using sandbags or other suitable tethered anchoring system spaced on a 10 foot grid spacing.
- Overlap seams 1-2 feet, tape, roll and stake the seams and then weigh down the entire length.

#### Inspection & Maintenance

- Replace torn sheets and repair open seams.
- Completely remove and replace plastic when it begins to deteriorate.
- Completely remove all plastic once it is no longer needed.
- Check anchoring system and repair or add anchors.

FOR FURTHER INFORMATION  
ON DESIGN CRITERIA SEE  
CHAPTER 4 OF EROSION  
PREVENTION AND SEDIMENT  
CONTROL PLANNING AND  
DESIGN MANUAL.

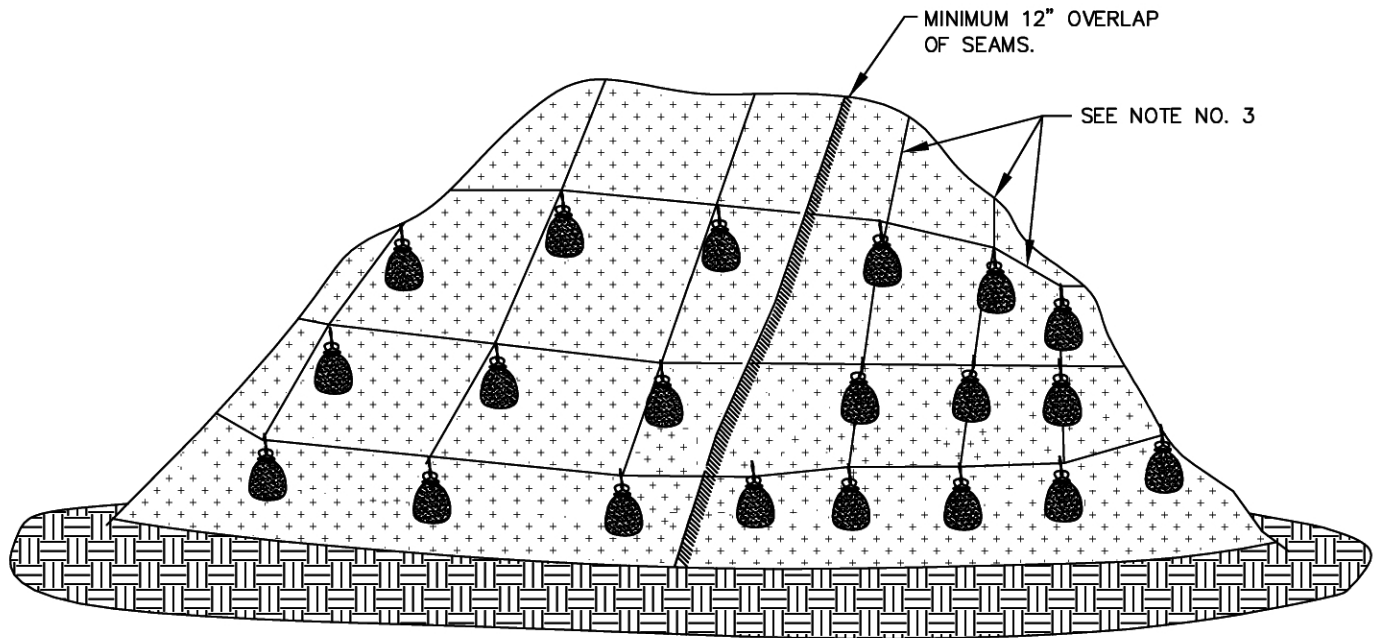

## PLASTIC SHEETING

### NOTES:

1. MINIMUM 12" OVERLAP OF ALL SEAMS REQUIRED.
2. PERIMETER SEDIMENT CONTROL BMP TO BE INSTALLED A MIINIMUM OF 3' FROM TOE OF STOCKPILE.
3. COVERING MAINTAINED TIGHTLY IN PLACE BY USING SANDBAGS OR APPROVED EQUAL ON ROPES WITH A MAXIMUM 10' GRID SPACING IN ALL DIRECTIONS.
4. PLASTIC TO EXTEND MINIMUM 1' BEYOND TOE OF SLOPE.
5. AS APPROPRIATE, BMP'S SHALL BE INSTALLED TO CONVEY WATER DISCHARGE FROM STOCKPILE AREAS.

## PLASTIC SHEETING

This page intentionally left blank.

# SEEDING TEMPORARY/PERMANENT

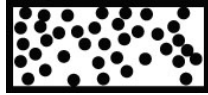

### 4.1.8 Seeding (Temporary/Permanent)

A well-established vegetative cover is one of the most effective methods of reducing erosion. Vegetation should be established on construction sites as the slopes are finished, rather than waiting until all the grading is complete. To ensure seed germination and adequate vegetation establishment, temporary or permanent seeding applications should be completed prior to September 1<sup>st</sup> of that year.

#### Advantages

- Eliminates splash erosion.
- Traps sediment.
- Promotes infiltration.
- Reduces runoff velocities.
- Provides excellent stabilization.
- Relatively inexpensive erosion control measure.
- Effective for dust control

#### Disadvantages

- Needs sufficient time for seed to establish.
- Requires mulch or other cover until vegetation is established.
- May require fertilizer and lime to establish on poor soils.
- May require irrigation.
- Must be removed prior to applying fill material.

#### Design Criteria

The following sections present general information regarding seeding, bed preparation, mulching and fertilizing.

#### Selection Criteria

Standard grass and legume seed mixes for erosion control purposes are developed by local or regional distributors for site specific applications. Often more than one grass species is selected so that at least one species will do well given the extreme seasonal fluctuations that occur in the region.

Seedling vigor is an important plant characteristic to consider for erosion control seeding because the goal is to have rapid establishment and a dense fibrous root system. This holds the soil in place and provides a thick canopy over the soil to break the raindrop velocity. Some grasses do well early in the season and can act as nurse or cover crops until the slower growing species can

## CHAPTER 4: EROSION AND SEDIMENT CONTROL MEASURES AND BMPs

---

establish. Seed mixes are developed for specific climatic zones around the state to match the optimum growing conditions for each species.

One grass seed characteristic that is considered is the season that predominant growth will occur. Grass species are often characterized as being either warm or cool season grasses. A warm season grasses, such as bluegrass, will have its predominant growth during the warm months of the year. Conversely, cool-season grasses, like hard fescue, have its predominant growth in the cool weather and produces seeds in the early spring. To optimize establishment, a cool or warm season grass, or both, may be used depending on whether the seed is planted in the spring or fall.

Another seed characteristic of importance in erosion control is the method by which the grass develops, grows and spreads. Grasses can be either rhizomatous, whereas the grass plant will send out runners that will start new growth, a bunch grass, or a sod-forming grass. Rooting depth is important and grasses are characterized as being deep, moderate and shallow rooting for erosion control purposes. The mixture of rooting depths provides optimum support for soils and best enables the removal of water by the roots at the various zones in the soil.

### Seed Purity

All seed furnished to the operator should be those specified in the project plan and should be measured by Pure Live Seed (PLS) weight. Pure Live Seed refers to the portion of a seed lot that is live seed of the desired kind. The purpose of measuring the application on a PLS basis is so that trash and empty seeds do not confuse seeding rate calculations.

All seeds applied for temporary erosion control must be certified in accordance with the Standard Specifications. Seed certification insures varietal purity and seed quality. The seed label must have the following information included:

- Origin.
- The kind and variety of each seed in a mixture, of 3% or more.
- Percent of germination - the percentage of the pure seed that has started to grow by the end of the specified test period. Germination declines with the age of the seed, the variety and storage conditions - always check the date of the test. Total germination for the purpose of PLS calculations is equal to the percent germination from seed test plus percent hard seed.
- Percent of pure seed - the percentage of seed without dirt, dust, chaff, straw, empty kernels, weed, other crops, and other foreign matter. Purity, inert matter, weed seed, other crop seed, and hard seed percentages are shown on the seed tag - they add up to 100%.
- Percent and kind of other crop – the percentage of crop seed other than the specified crop as labeled.



## CHAPTER 4: EROSION AND SEDIMENT CONTROL MEASURES AND BMPs

---

- Percent of inert matter - the percentage by weight of broken seeds one-half or less of full size and all other dead foreign material.
- Percent of weed seed - the percentage by weight of seeds considered weeds by law.
- Percent of noxious weed seed - the percentage of seed considered noxious by law. Refer to Oregon Department of Agriculture website:  
<https://www.oregon.gov/ODA/programs/MarketAccess/SeedRegProgram/Pages/OregonSeedLaws.aspx>
- Name and number per pound of restricted noxious weed seeds present.
- Percent of hard seed - the percentage by weight of the labeled crop that remain sound but do not germinate at the end of the test periods. They may germinate later.
- Test date (month and year).
- Name and address of labeler.
- Lot weight.

The label must be correct. The purity, germination and other information on the tag must be backed by a seed lab analysis report. High quality seed germinates well, has a high purity percentage, and is free of noxious weeds. The identity, purity and uniformity of the seed must be maintained at all times. The seed is tested and must meet the minimum seed standards. Lots showing Oregon prohibited weeds are not approved. Seed must meet minimum viability standards. Oregon State University Extension Service keeps a listing of seed varieties that are certified in the [OSU Extension Certified Seed Handbook](#). The seed variety must be approved by the OSU Seed Certification Board to be eligible for certification or meet the standards for certification.

### **Application and Establishment**

- Temporary grass cover measures must be fully established prior to the wet weather season. Other ground cover measures will have to be implemented if establishment is not obtained. In order to establish an 80% healthy stand of grass, all seeding applications should be completed prior to September 1<sup>st</sup>.
- Apply permanent seeding when no further disturbances are planned.
- Seed should be applied immediately after seedbed preparation while the soil is loose and moist.
- Apply seed before applying straw mulch or other ground cover applications.
- Hydromulch shall be applied with grass seed at a rate of 2000 lb./acre. On slopes steeper than 10%, hydroseed and mulch shall be applied with a bonding agent (tackifier). Application rate and methodology to be in accordance with seed supplier recommendations. (See Appendix C for help)

## CHAPTER 4: EROSION AND SEDIMENT CONTROL MEASURES AND BMPs

---

- Dry, loose, weed-free straw used as mulch shall be applied at double the hydromulch application requirement (4000 lb./acre). Anchor straw by working in by hand or with equipment (rollers, cleat tracks, etc).
- Permanent or temporary irrigation is recommended and should be supplied, especially in abnormally hot or dry weather or on adverse sites. Water application rates should be controlled to provide adequate moisture without causing runoff.

### Site Preparation

- Bring the seedbed area to final grade, remove all rocks and debris, and smooth surface undulations larger than 2 inches.
- Divert concentrated flows away from areas that are to be seeded and during establishment.
- For optimum seeding conditions, preserve topsoil and stockpile material until final grades are established. Spread topsoil over new grades or:
  - Conduct soil test to determine pH and nutrient content.
  - Roughen the soil by harrowing, tracking, grooving or furrowing.
  - Apply amendments as needed to adjust pH to 6.0-7.5. Incorporate these amendments into the soil.
- The seedbed should be firm but not compact. The top 4-6 inches of soil should be loose, moist and free of large clods and stones.
- If the seedbed has been idle long enough for the soil to become compact, the topsoil should be harrowed with a disk, spring tooth drag, spike tooth drag, or other equipment designed to condition the soil for seeding.
- Harrowing, tracking or furrowing should be done horizontally across the face of the slope, so ridges are along the slope contour.

### Seeding

- Seed to soil contact is the key to good germination.
- Apply seed at the rates specified using calibrated seed spreaders, cyclone seeders, mechanical drills, or hydroseeder so the seed is applied uniformly on the site
- Broadcast seed should be incorporated into the soil by raking or chain dragging, and then lightly compacting to provide good seed-soil contact.
- Apply mulch and tackifier or matting, as specified, over the seeded areas.
- To prevent seed from being washed away, confirm installation of all required surface water controls.
- Double the rate of seed application when mulch and seed are applied in a single application.

## CHAPTER 4: EROSION AND SEDIMENT CONTROL MEASURES AND BMPs

---

- Recommended erosion control grass seed mixes are as follows. Similar mixes designed to achieve erosion control may be substituted if approved by local jurisdiction:
  1. Dwarf Grass Mix (low height, low maintenance)  
Dwarf Perennial Ryegrass, 80% by weight  
Creeping Red Fescue, 20% by weight  
Application rate: 100 pounds minimum per acre
  2. Standard Height Grass Mix  
Annual Ryegrass, 40% by weight  
Turf-type Fescue, 60% by weight  
Application rate: 100 pounds minimum per acre

### Fertilizer

- Slow-release fertilizers are more efficient and have fewer environmental impacts. Areas being seeded for final landscaping may require soil tests to determine the exact type and quantity of fertilizer needed to prevent the over-application of fertilizer.
- Use non-phosphorus fertilizer on disturbed areas within 50 feet of water bodies and wetlands.
- The use of stockpiled topsoil or compost reduces the need for fertilizer and improves the overall soil quality.
- Provide project-specific application rates

### Mulch

- Refer to Ground Cover and Matting sections of this chapter.
- Straw mulch in loose condition is preferred for seeding during the wet season on slopes 3:1 or flatter.
- Straw mulch may be required during the dry season if:
  - Grass growth is expected to be slow;
  - The soils are highly erodible;
  - There is a water body close to the disturbed area; or
  - Significant precipitation is anticipated before the grass will provide effective cover.
- The straw mulch shall not be moldy, caked, decayed or of otherwise low quality.
- Can be applied on top of the seed or applied with the seed during hydroseeding. The application rate of seed per acre should be increased if seed and mulch are applied in a single application.

## CHAPTER 4: EROSION AND SEDIMENT CONTROL MEASURES AND BMPs

---

### Hydroseed

- Refer to Hydraulic Application section of this chapter. Hydroseeding requires a mulch or green dye tracer as a visual aid during application.
- On slopes steeper than 2:1, hydroseeding requires an increased rate of tackifier to be applied.
- During the dry season, hydroseeding with wood fiber mulch is adequate.

### Inspection & Maintenance

- Newly seeded areas need to be inspected frequently to ensure the grass is growing.
- If the seeded area is damaged due to runoff, additional BMPs may be needed. Re-seed and mulch damaged areas.
- Spot seeding can be done on small areas to fill in bare spots where grass did not grow properly.
- If spot seeding is ineffective, use an alternate method, such as sod or matting.
- Re-seed and protect with mulch any areas affected by erosion. If the erosion is caused by concentrated runoff, fix the runoff problem and then re-seed, mat the area.

### 4.1.9 Sod

Establishes permanent turf for immediate erosion protection and stabilizes drainage ways.

#### Advantages

- Provides immediate, effective protection, and is aesthetically pleasing.
- Provides high-density vegetation, which is superior to a recently seeded area.
- Placement can occur any time that soil moisture is adequate and the ground is not frozen.

#### Disadvantages

- Can be more costly than other BMPs.
- Availability is seasonal.
- Irrigation may be required if installed in summer.
- Difficult to mow if installed on slopes steeper than 3:1.
- Installations in grassed waterways may roll up if not anchored or drained properly.
- Time necessary for root establishment may be lengthy.

#### Design Criteria

- Use sod as a short or long-term cover.
- Use sod around inlets located off paved areas.
- Use sod that is generally weed free, has uniform thickness (approximately 1 inch thick) and dense root mat for mechanical strength.
- Generally inappropriate for bioswales. Sod can be used for lining ditches or waterways carrying intermittent flows.
- The following steps are general recommendations for sod installation:
  - Shape and smooth the surface to final grade in accordance with the approved grading plan.
  - Fertilize as per supplier's recommendations. Use non-phosphorus fertilizer on disturbed areas within 50 feet of water bodies and wetlands.
  - Work lime and fertilizer into soil 1-2 inches deep and smooth the surface.
  - Lay sod strips perpendicular to the direction of water flow, beginning at the lowest area to be sodded. Wedge strips securely into place and square the ends of each strip to provide for a close, tight fit. Stagger joints at least 12 inches. Staple sod onto 3:1 and steeper slopes.
    - Roll the sodded area and irrigate.
    - Not for use in high velocity channels/ditches

## CHAPTER 4: EROSION AND SEDIMENT CONTROL MEASURES AND BMPs

---

### Inspection & Maintenance

- Inspect sod area frequently for soil moisture content and root establishment.
- Re-tack, re-sod or re-seed as necessary.
- If it is impossible to establish a healthy ground cover due to frequent saturation, instability, or some other cause; remove the sod, seed the area with an appropriate mix, and protect with matting.

### 4.2 Runoff Control Best Management Practices

The greater the volume and velocity of surface water runoff on construction sites, the more sediment and other pollutants can be transported to streams, wetlands, and lakes. Diverting runoff away from exposed soils can greatly reduce the amount of soil eroded from a site. Decreasing runoff velocities reduces erosion and the amount of pollutants carried off-site.

Runoff controls divert runoff from exposed areas and reduce runoff velocities. Examples of runoff control BMPs that divert runoff from exposed areas include diversion swales, pipe slope drains and grass-lined swale. Examples of runoff control BMPs that reduce runoff velocities include check dams, outlet protection and surface roughening.

1. Check Dam
2. Diversion Dike/Swale
3. Grass-lined Swale
4. Outlet Protection
5. Pipe Slope Drain
6. Surface Roughening

# CHECK DAM





### 4.2.1 Check Dam

A check dam is a small dam or weir constructed across a swale or ditch to reduce velocities of concentrated flows, thereby reducing erosion in the swale or ditch. Check dams can not only prevent gully erosion from occurring before vegetation is established, but can also allow a significant amount of suspended sediment to settle out.

#### Advantages

- Prevent erosion and promote settling of sediment in runoff.
- When carefully located and constructed, check dams may function as permanent installations.
- Reduces flow velocity
- Inexpensive and easy to install.
- Rock can be spread into ditch and used as a channel lining when the check dam is no longer necessary.
- Some pre-fabricated check dams are reusable.

#### Disadvantages

- Removal may be costly for some types of check dams.
- Suitable only for a limited drainage area.
- May reduce hydraulic capacity of the channel.
- May create turbulence downstream, causing erosion of the channel banks.
- Pondered water may kill grass in grass-lined channels.
- May be an obstruction to construction equipment.

#### Design Criteria

- Check Dams can be constructed from a variety of materials.
  - Rock: Rock material only.
  - Bio-filter Bags: Bio-filter bags staked to the ground.
  - Sand Bags
  - Pre-fabricated Check Dam System: A manufactured system specifically designed to slow water so that suspended particles settle out. Field fabricated systems are not allowed.
- Use in temporary or permanent channels not yet vegetated when installing channel lining is not feasible.
- Use in small open channels that drain 10 acres or less.
- Not for use in streams or rivers.

## CHAPTER 4: EROSION AND SEDIMENT CONTROL MEASURES AND BMPs

- Construct rock check dams sized to stay in place given the expected design flow velocity. Typical rock size of 3-6 inch. Place rock by hand or by mechanical means, avoid dumping the rock.
- Bridge entire ditch or swale width and ensure the center of the dam is 6 inches lower than the outer ends.
- Remove check dams from grass-lined ditches and swales once the grass is established, unless intended for permanent installation.
- Seed, mulch, or mat the area where the check dams were, immediately following removal.
- Space check dams according to the following table.

**Table 4-4 Spacing for check dams**

Ditch Grade	Minimum Weir Depth		
	6 inch	12 inch	18 inch
6%	**	16 ft O.C.	26 ft O.C.
5%	**	20 ft	30 ft
4%	**	26 ft	40 ft
3%	15 ft	33 ft	50 ft
2%	25 ft	50 ft	80 ft

\*\* Not Allowed

### Inspection & Maintenance

- Remove sediment once it reaches one-third the depth of the check dam.
- Replace rock check dam when filtering capacity is reduced by one-half.

FOR FURTHER INFORMATION  
ON DESIGN CRITERIA SEE  
CHAPTER 4 OF EROSION  
PREVENTION AND SEDIMENT  
CONTROL PLANNING AND  
DESIGN MANUAL.

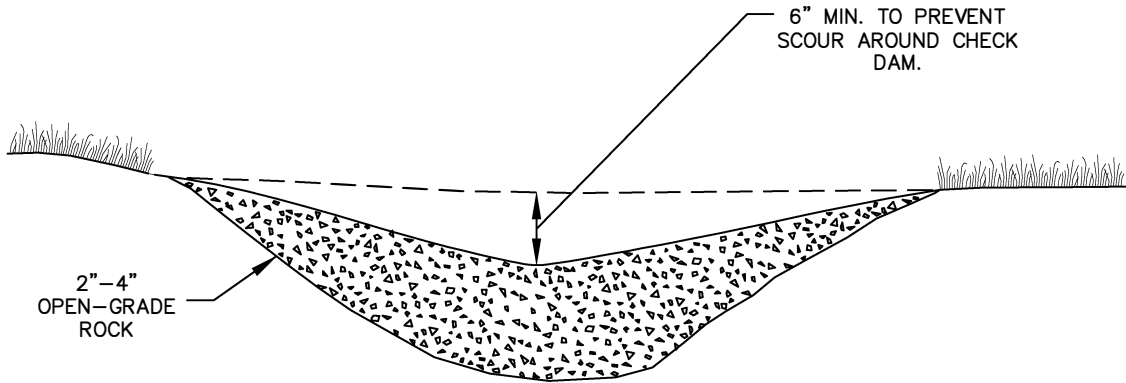

### ROCK CHECK DAM

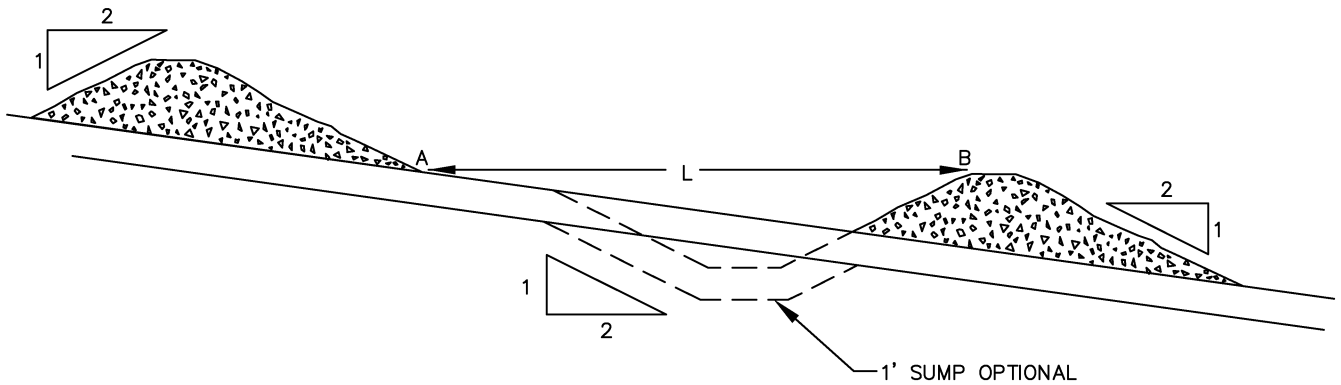

### SPACING BETWEEN CHECK DAMS

NOTES:

1. L = THE DISTANCE SUCH THAT POINTS A AND B ARE OF EQUAL ELEVATION.
2. SEE DRAWING 4-28 FOR HEIGHT AND SPACING OF CHECK DAMS.

CHECK DAM  
ROCK

FOR FURTHER INFORMATION  
ON DESIGN CRITERIA SEE  
CHAPTER 4 OF EROSION  
PREVENTION AND SEDIMENT  
CONTROL PLANNING AND  
DESIGN MANUAL.

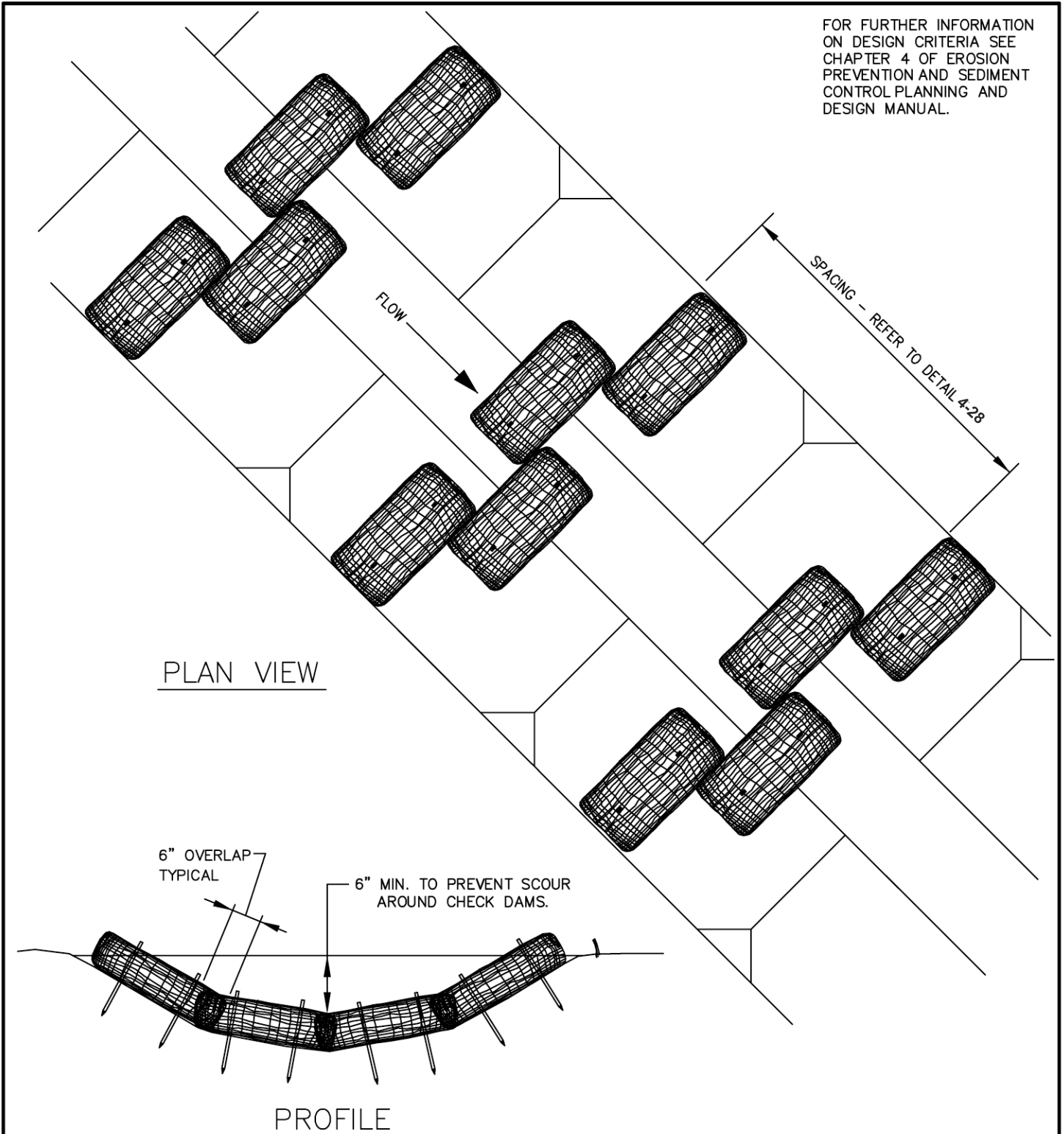

PLAN VIEW

PROFILE

NOTES:

1. STAKING OF BAGS REQUIRED USING (2) 1"X2" WOOD STAKES OR APPROVED EQUAL PER BAG.
2. SURFACE MUST BE SMOOTH BEFORE APPLICATION.
3. CHECK DAMS CAN BE CONSTRUCTED USING STRAW WATTLES OR OTHER MATERIALS AS APPROVED BY THE DISTRICT OR CITY.

# CHECK DAM BIO-FILTER BAG

DRAWING NO. 4-9

REVISED 10-31-19

This page intentionally left blank.

## DIVERSION DIKE/SWALE

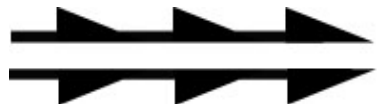

Diversion Dike/Swale



Diversion Dike



Diversion Swale



### 4.2.2 Diversion Dike/ Swale

A diversion dike/swale is a ridge of compacted soil or a lined swale with vegetative lining located at the top, base or somewhere along a sloping disturbed area. The dike or swale intercepts and conveys smaller flows along low-gradient drainage ways to larger conveyances such as ditches or pipe slope drains or to a stabilized outlet. Dikes and swales may be used singly or in combination with each other.

#### Advantages

- Provides a practical, inexpensive method to divert runoff.
- Can handle flows from large drainage areas.
- Use on-site material and equipment to construct.

#### Disadvantages

- If improperly constructed, can contribute to erosion caused by concentrating the flow.
- High flow velocity can damage vegetation.
- Not effective for preventing illegal discharge.

#### Design Criteria

- Refer to Table 4-5 Dike Design Criteria and Table 4-6 Swale Design Criteria.
- Install the dike and/or swale horizontally at intervals across a disturbed slope. Space horizontal interceptor dikes and swales according to Tables 4-5 and 4-6.
- For slopes of erodible soils, steeper than 2:1 with more than 10 ft. of vertical relief, construct benches or shorten distance between dikes or swales.
- If the dike or swale intercepts runoff from disturbed areas, discharge the runoff to a stable conveyance system that routes the runoff to a sediment trap or basin.
- If the dike or swale intercepts runoff that originates from undisturbed areas, discharge the runoff to a stable conveyance system that will route the runoff downslope of any disturbed areas and release the water at a stabilized outlet.
- May need matting to protect seed bed and channel from erosion.

**CHAPTER 4: EROSION AND SEDIMENT CONTROL MEASURES AND BMPs**

---

**Table 4-5     Diversion dike design criteria**

Top Width	2 ft. min.	
Height	18 in. min. Measured from upslope toe and at a 90% standard proctor compaction ASTM D698.	
Side Slopes	2H:1V or flatter	
Grade	Topography Dependent	
Dike grade	Maximum 5%	
Slope of Disturbed Area vs. Horizontal Spacing	<5%	300 ft
	5-10%	200 ft
	10-25%	100 ft
	25-50%	50 ft
Slope Stabilization	<5% Seed and mulch within 5 days following dike construction	
	5-40% Stabilize immediately using either sod, riprap or appropriate matting.	
Outlet	Upslope side of dike provides positive drainage to the outlet. Provide energy dissipation as necessary to prevent erosion. Release sediment-laden runoff to a sediment trapping facility.	



## CHAPTER 4: EROSION AND SEDIMENT CONTROL MEASURES AND BMPs

---

**Table 4-6     Diversion swale design criteria**

Bottom Width	2 ft. min. The bottom should be level across the swale.	
Depth	1 ft.	
Side Slopes	2:1 or flatter	
Grade	Maximum 5% with positive drainage to a suitable outlet.	
Slope of Disturbed Area vs. Horizontal Spacing	<5%	300 ft.
	5-10%	200 ft.
	10-25%	100 ft.
	25-50%	50 ft.
Slope Stabilization	Temporarily seed or line with riprap 12 in. thick and press into the bank approximately 3-4 in.	
Outlet	Level spreader or riprap to stabilized outlet/sedimentation pond.	

### Inspection & Maintenance

- Inspect and repair as necessary after every major storm.
- Minimize construction traffic over temporary dikes and swales.
- Immediately repair damage resulting from runoff or construction activities.
- If the dike or swale regularly overflows, increase the capacity and/or frequency of the dikes/swales.
- Clean out clogged pipes (as part of the swale system) under roads.

### 4.2.3 Grass-lined Swale

A grass-lined swale is a channel with a vegetative lining constructed to convey and dispose of concentrated surface runoff.

#### Advantages

- Does not generate high velocity runoff and offers temporary slope protection, which is superior to plastic sheeting.
- Offers storage opportunity for runoff.
- Captures a great deal of sediment due to the filtering effect of vegetation.
- Usually easy to install.

#### Disadvantages

- May require temporary irrigation to establish vegetation.
- Should not be used until vegetation is completely established.

#### Design Criteria

As a minimum, grass-lined channels should carry a peak runoff from a 10-year storm event without eroding. Where flood hazards exist, increase the capacity according to the potential for damage. The allowable design velocity for grassed-lined channels is based on soil conditions, type of vegetation, and the method of establishment. The channel shape may be parabolic, trapezoidal, or v-shaped, depending on the need and site conditions. Small check dams or flow spreaders may be necessary to minimize channelization.

#### Inspection & Maintenance

- During the initial establishment, grass-lined channels should be repaired and grass re-established as necessary.
- After grass has become established, the channel should be checked periodically to determine if the channel is withstanding flow velocities without damage.
- Check the channel for debris, scour, or erosion and immediately make repairs. It is particularly important to check the channel outlet and all road crossings for bank stability and evidence of piping or scour holes and make repairs immediately.
- Remove all significant sediment accumulations to maintain the designed carrying capacity.
- Keep the grass in a healthy, vigorous condition at all times, since it is the primary erosion protection for the channel.

## **CHAPTER 4: EROSION AND SEDIMENT CONTROL MEASURES AND BMPs**

---

- Permanent grassed waterways should be seasonally maintained by mowing and/or irrigating, depending on the type of vegetation selected.
- Newly seeded areas need to be inspected frequently to ensure the grass is growing.
- If the seeded area is damaged due to runoff, additional storm water measures such as check dams or matting may be needed.

FOR FURTHER INFORMATION  
ON DESIGN CRITERIA SEE  
CHAPTER 4 OF EROSION  
PREVENTION AND SEDIMENT  
CONTROL PLANNING AND  
DESIGN MANUAL.

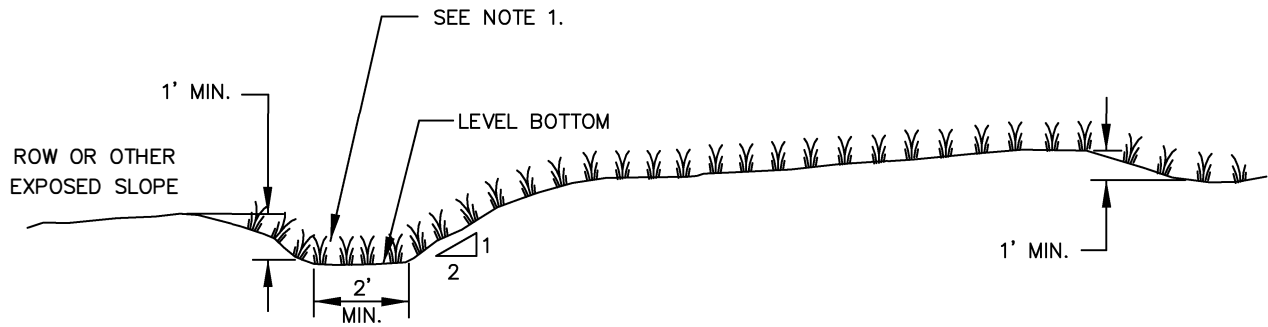

- BOTTOM WIDTH – 2 FEET MINIMUM; THE BOTTOM WIDTH SHALL BE LEVEL.
- DEPTH – 1 FOOT MINIMUM.
- SIDE SLOPE – 2H:1V OR FLATTER.
- GRADE – MAXIMUM 5 PERCENT, WITH POSITIVE DRAINAGE TO A SUITABLE OUTLET (SUCH AS SEDIMENTATION POND)

### DIVERSION SWALE

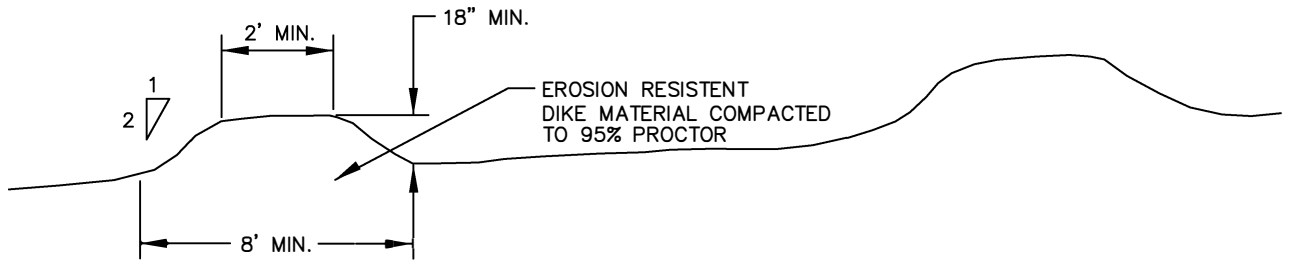

### DIVERSION DIKE

<u>SLOPE</u>	<u>SPACING</u>
<5%	300 FEET
5–10%	200 FEET
10–40%	100 FEET

NOTE:

1. ESTABLISH VEGETATION AND/OR APPLY APPROVED EROSION PREVENTION BMPs IMMEDIATELY UPON CONSTRUCTION.

## DIVERSION DIKE / SWALE

This page intentionally left blank.

# OUTLET PROTECTION

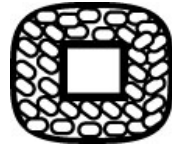

### 4.2.4 Outlet Protection

Outlet protection reduces the speed of concentrated flow, thereby preventing scour at conveyance outlets. By dissipating energy, outlet protection lowers the potential for downstream erosion. Outlet protection includes riprap-lined basins, concrete aprons, and settling basins. Outlet protection prevents scour at storm water outlets, and minimizes the potential for downstream erosion.

#### Advantages

- Many techniques are effective and relatively inexpensive and easy to install.
- Removes sediment and reduces velocity.

#### Disadvantages

- Can be unsightly.
- May be difficult to remove sediment without removing and replacing the structure itself.
- Rock outlets with high velocity flows may require frequent maintenance.

#### Design Criteria

- Use the standard detail for outlet protection as a minimum. Consider site conditions to determine if a more complex energy dissipater may be required.
- Use at the outlets of ponds, pipe slope drains, ditches, or other conveyances, and where runoff is conveyed to a natural or man-made drainage feature such as a stream, wetland, lake, or ditch.

#### Inspection & Maintenance

- If there is scour at the outlet, repair damage and evaluate if outlet needs additional protection.
- Remove accumulated sediment frequently.

FOR FURTHER INFORMATION  
ON DESIGN CRITERIA SEE  
CHAPTER 4 OF EROSION  
PREVENTION AND SEDIMENT  
CONTROL PLANNING AND  
DESIGN MANUAL.

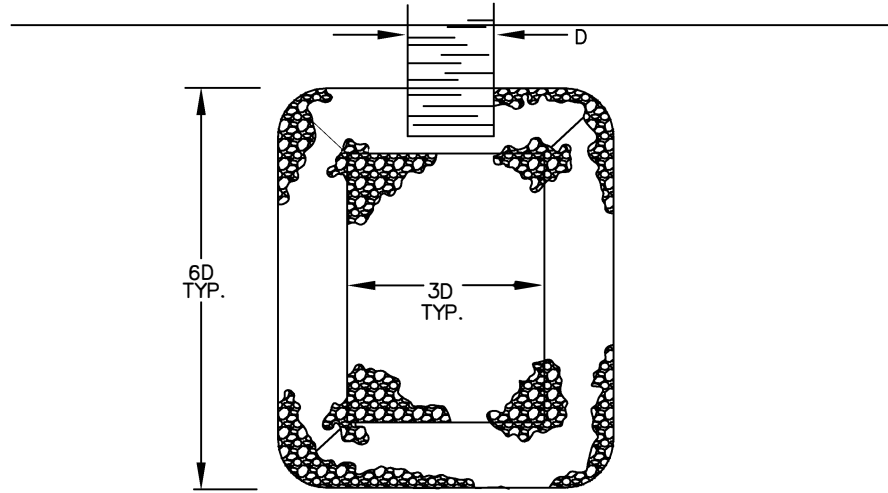

PLAN VIEW

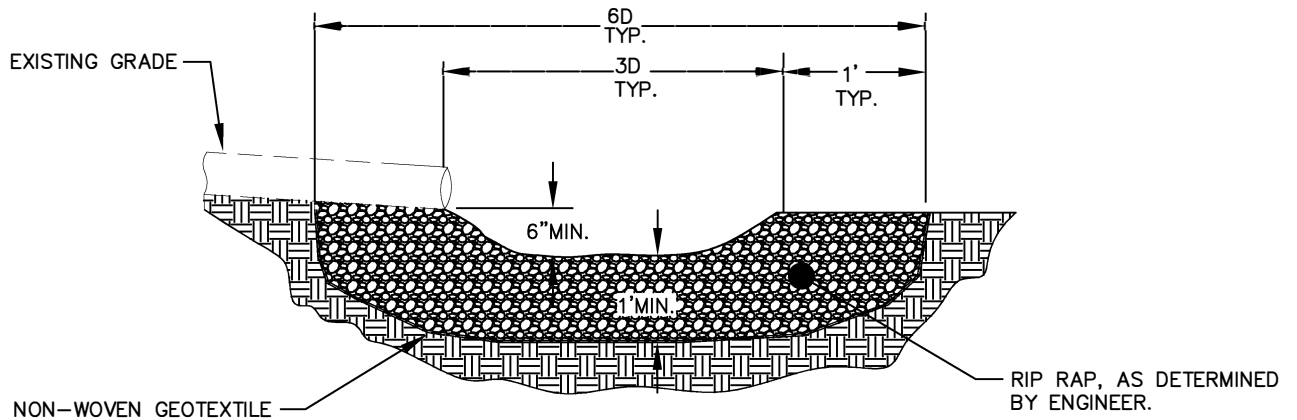

PROFILE

NOTE:

1. ADDITIONAL BMP'S ARE REQUIRED WHEN DISCHARGING SEDIMENT LADEN WATER.

# OUTLET PROTECTION RIP RAP



FOR FURTHER INFORMATION  
ON DESIGN CRITERIA SEE  
CHAPTER 4 OF EROSION  
PREVENTION AND SEDIMENT  
CONTROL PLANNING AND  
DESIGN MANUAL.

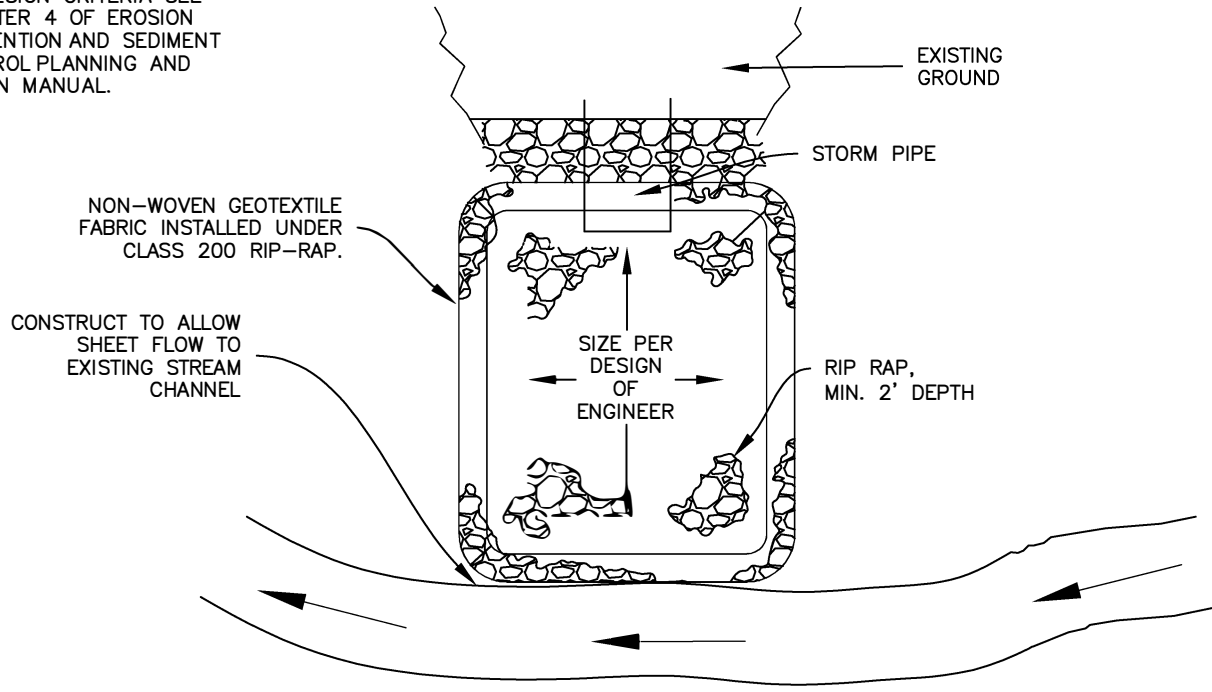

PLAN VIEW  
NTS

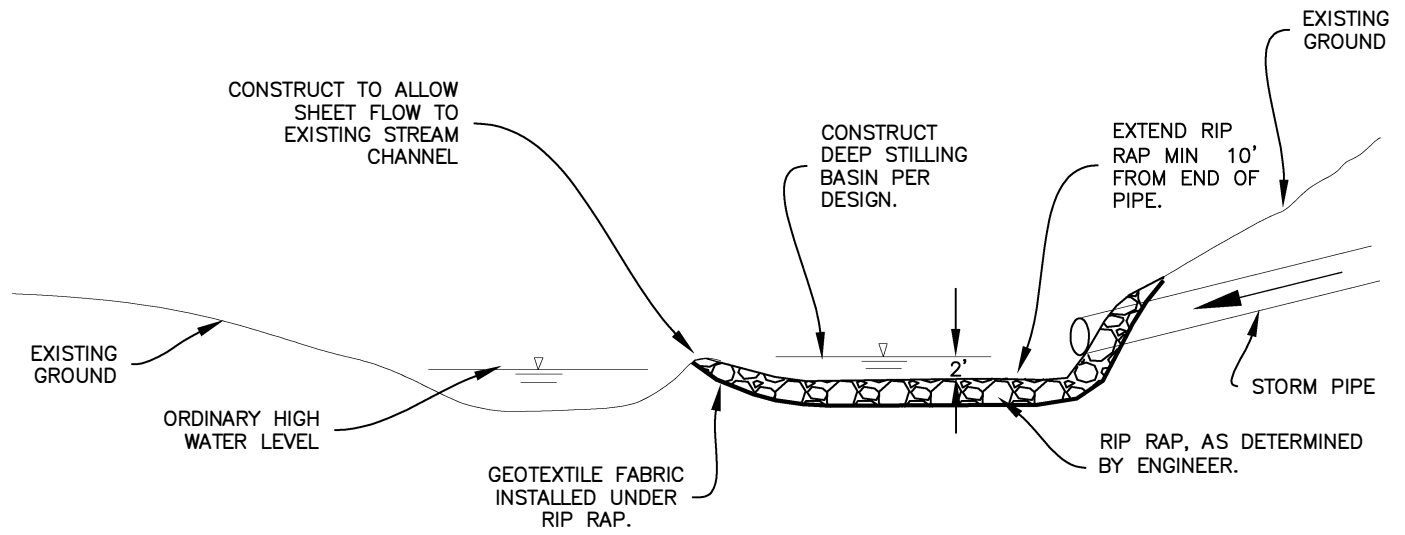

PROFILE

NOTES:

1. ADDITIONAL BMP'S ARE REQUIRED WHEN DISCHARGING SEDIMENT LADEN WATER.
2. CONTRACTOR TO COMPLY WITH CONDITIONS AND REQUIREMENT OF DSL AND CORPS PERMITS.

OUTLET PROTECTION  
STILLING BASIN

This page intentionally left blank.

# PIPE SLOPE DRAIN



### 4.2.5 Pipe Slope Drain

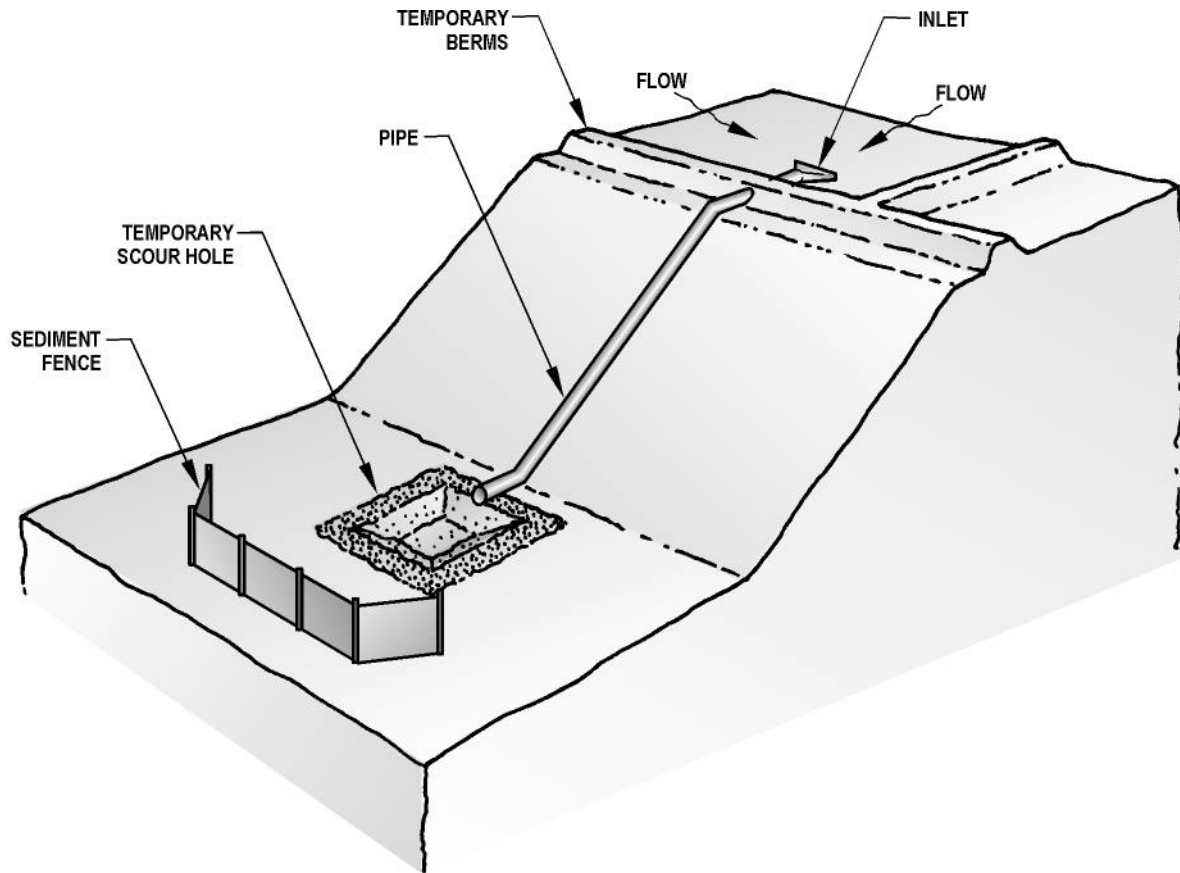

A pipe slope drain is a pipe extending from the top to the bottom of a cut or fill and discharging into a stabilized watercourse, a sediment trapping device or onto a stabilized vegetated area. The pipe slope drain carries concentrated runoff down steep slopes without causing gullies, erosion, or saturation of slide-prone soils.

#### Advantages

- Effective method of conveying water down steep slopes.
- Reduces or eliminates erosion.
- Easy installation and little maintenance.

#### Disadvantages

- Drain can be under-designed or incorrectly located.
- Area cleared for drain installation requires stabilization to prevent erosion from occurring under the pipe.

## CHAPTER 4: EROSION AND SEDIMENT CONTROL MEASURES AND BMPs

- Outfall systems constructed of pipe segments, which are banded and/or gasketed together, could develop leaks causing erosion and failure of the system. Failures on erodible or steep slopes can cause downstream sedimentation or even mudflows.
- Adjustment of pipe lengths is necessary as cut and fill slopes are extended.

### Design Criteria

- Capacity – Peak runoff from a 10-yr storm. Inlet control is a critical factor when sizing pipes. Unless they are individually designed, size drains according to Table 4-7.
- Use on any slope where a large amount of flow must be collected and conveyed to avoid erosion.
- Use in areas where clean water should be kept separate from sediment-laden water.
- If a permanent measure is needed, it should be designed as part of the project drainage facilities.

**Table 4-7 Slope drain sizes**

<b>Contributing Drainage Area (Maximum)</b>	<b>Pipe Diameter</b>
0.50 acre	12 inch
0.75 acre	15 inch
1.00 acre	18 inch

- Consider using continuously fused, welded or flange-bolted mechanical joint systems with proper anchoring or HDPP (high-density polyethylene pipe) for outfalls on steep slopes.
- Show the entrance sloped toward the pipe inlet.
- At the inlet, show interceptor dikes that are at least 12 in. higher at all points than the top of the inlet pipe and placed to direct water into the pipe.
- If the pipe slope drain will convey sediment-laden runoff, direct the runoff to a sediment retention facility.
- If the runoff is not from a disturbed area or is conveyed from a sediment trap or pond, convey the runoff to a stabilized discharge point.
- Energy Dissipation – Scour holes or riprap-lined stilling basins prevent most scour problems at outfalls.

## CHAPTER 4: EROSION AND SEDIMENT CONTROL MEASURES AND BMPs

---

- Consider site conditions to determine if a more complex energy dissipater may be required.
- The special provisions and typical notes on the ESCP should include the following installation notes/details:
  - Minimize disturbance during installation. In some circumstances, this requires HDPP installed by hand.
  - Slope anchor details.
  - Immediately stabilize any area disturbed during installation or maintenance.
  - Securely connect the standard flared end section at the entrance to the slope drain, using watertight connecting bands.
- Pipe should be staked securely to prevent movement
  - Securely fasten together the slope drain sections with gasketed watertight fittings, and securely anchor the sections into the soil.
  - Stabilize the area below the outlet following the energy dissipater.

### Inspection & Maintenance

- Adjust lengths of pipe when cut and fill slopes are extended.
- Regularly check the inlet and outlet points, especially following heavy rains. If there are signs of undercutting or water is going around the point of entry, reinforce the head wall with compacted earth or sand bags.
- Regularly check connection points for signs of erosion. Tighten fittings and repair erosion as needed.
- Immediately repair and install appropriate protection if erosion occurs at the outlet.

FOR FURTHER INFORMATION  
ON DESIGN CRITERIA SEE  
CHAPTER 4 OF EROSION  
PREVENTION AND SEDIMENT  
CONTROL PLANNING AND  
DESIGN MANUAL.

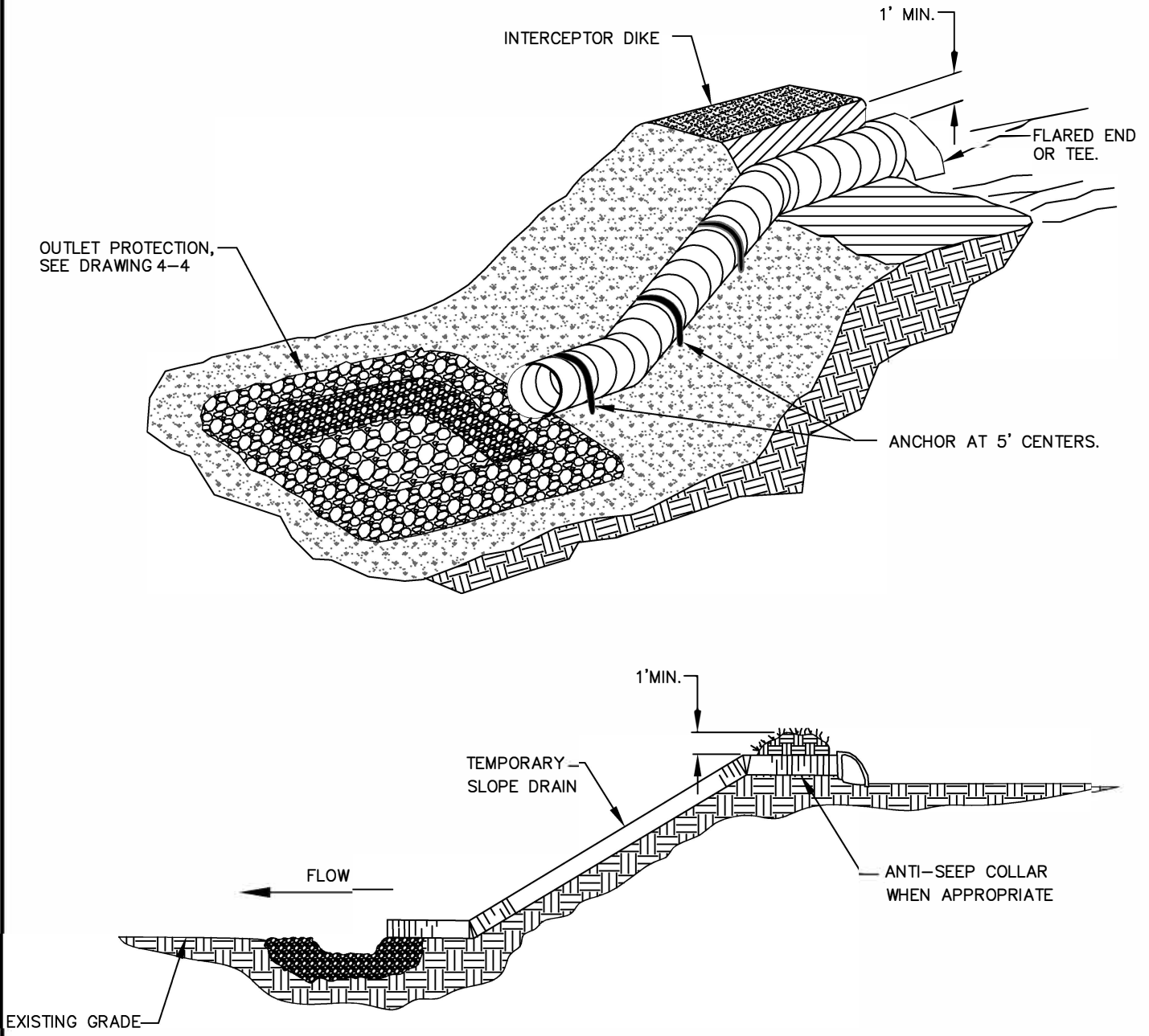

# PIPE SLOPE DRAIN

This page intentionally left blank.



# SURFACE ROUGHENING



### 4.2.6 Surface Roughening

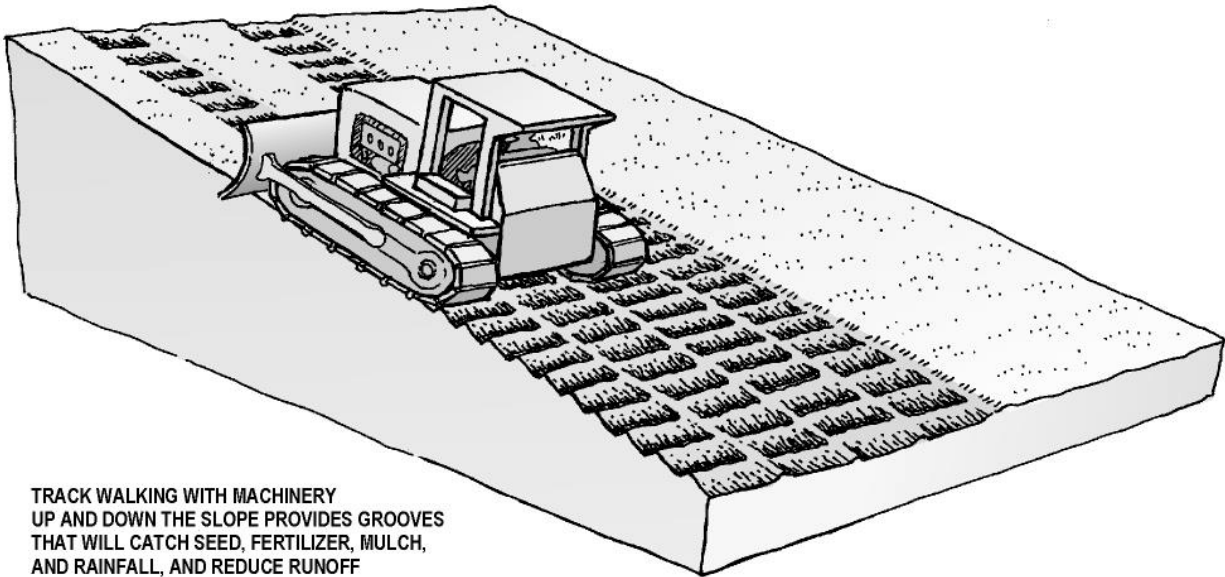

Surface roughening leaves the slopes in a roughened condition after clearing or creating a rough soil surface with horizontal depressions or grooves intended to trap seed and reduce runoff velocity. Roughening can be accomplished by ‘track walking’ slopes with tracked equipment, by using a serrated wing blade attached to the side of a bulldozer, or by other agricultural equipment.

#### Advantages

- Grooves can trap seed.
- Can increase vegetation establishment.
- Can reduce runoff velocity and increase infiltration.
- Can provide some instant protection from sheet erosion.
- Can trap soil eroded from the slopes above.

#### Disadvantages

- Tracking with a bulldozer or other heavy equipment may compact the soil.
- May increase time to finish slopes.
- Should not be relied upon as sole means of erosion control.
- Surface roughening should be done well prior to any forecasted storm event.
- Not appropriate for all types of soil, for example very sandy soil.

## CHAPTER 4: EROSION AND SEDIMENT CONTROL MEASURES AND BMPs

---

### Design Criteria

- Use on all slopes to be seeded.
- Use on slopes 3:1 or less, but can be used on steeper slopes in conjunction with the addition of staging sediment barriers.
- Immediately seed and mulch roughened areas to obtain optimum seed germination and growth.
- Height of track grousers should be 1 ½ inches or greater.
- Tracking should be accomplished by driving equipment **up** and **down** slope to create horizontal depressions/grooves.

### Cut Slope Roughening

- Stair-step grade or groove the cut slopes that are steeper than 3:1.
- Use stair-step grading on all erodible material soft enough to be ripped with a bulldozer. Slopes consisting of soft rock with the same subsoil are particularly suited to stair-step grading.
- Make the vertical cut distance less than the horizontal distance, and slightly slope the horizontal position of the "step" in toward the vertical wall.
- Do not make individual vertical cuts more than 2 feet high in soft materials or more than 3 feet in rocky materials.
- Groove the slope using machinery to create a series of ridges and depressions that run across the slope, on the contour.

### Fill Slope Roughening

- Place fill slopes with a gradient steeper than 3:1 in lifts not to exceed ½ foot, and make sure each lift is properly compacted.
- Ensure that the face of the slope consists of loose, uncompacted fill 4-6 inches deep.
- Use horizontal grooving along the contour or tracking to roughen the face of the slopes, if necessary.
- Apply seed, fertilizer and straw mulch, and then track or punch the mulch with a bulldozer.
- Do not blade or scrape the final slope face.

### Cuts, Fills, and Graded Areas

- Make mowed slopes no steeper than 3:1.
- Roughen these areas to shallow grooves by normal tilling, disking, harrowing, or use a cultipacker-seeder. Make the final pass of any such tillage on the contour.
- Excessive roughness is undesirable where mowing is planned.

## **CHAPTER 4: EROSION AND SEDIMENT CONTROL MEASURES AND BMPs**

---

### Inspection & Maintenance

- Check the seeded slopes for rills and washes. Fill these areas slightly above the original grade, then re-seed, mulch, or mat as soon as possible.

FOR FURTHER INFORMATION  
ON DESIGN CRITERIA SEE  
CHAPTER 4 OF EROSION  
PREVENTION AND SEDIMENT  
CONTROL PLANNING AND  
DESIGN MANUAL.

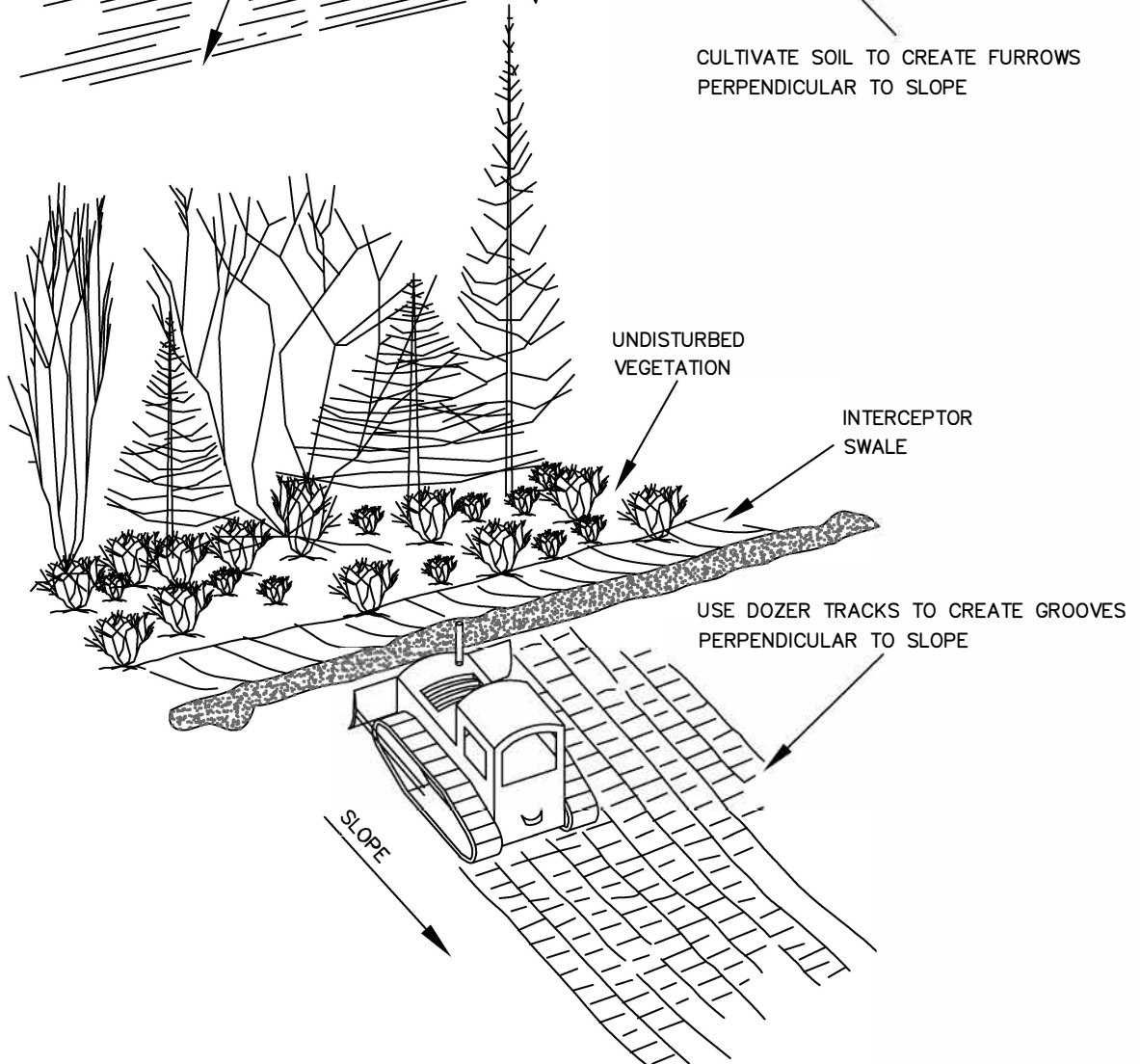
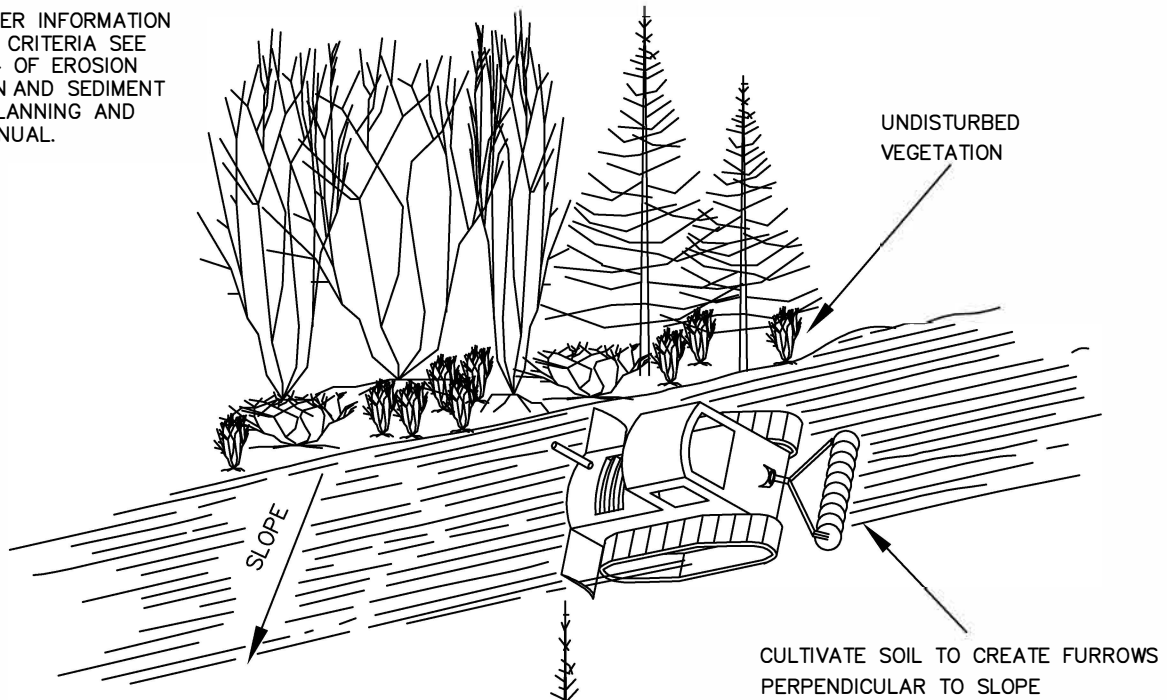

## SURFACE ROUGHENING CAT TRACKING

DRAWING NO. 4-6

REVISED 10-31-19

FOR FURTHER INFORMATION  
ON DESIGN CRITERIA SEE  
CHAPTER 4 OF EROSION  
PREVENTION AND SEDIMENT  
CONTROL PLANNING AND  
DESIGN MANUAL.

## STAIR STEPPING CUT SLOPES

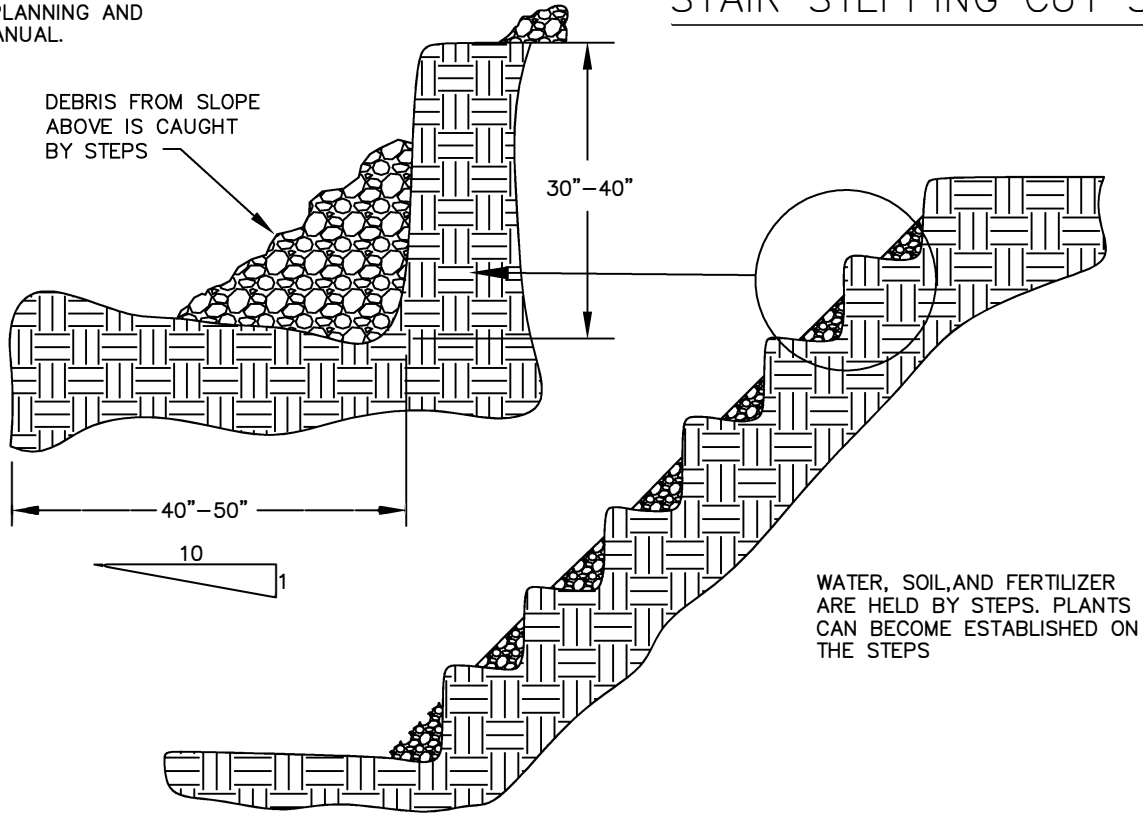

## GROOVING SLOPES

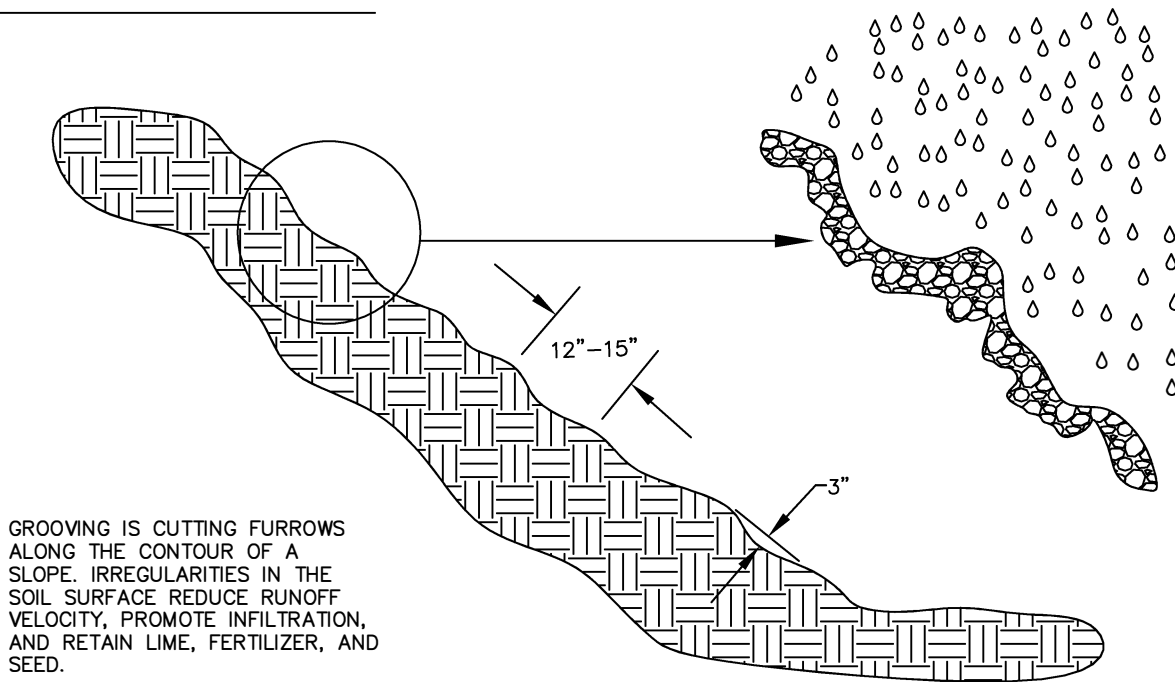

## SURFACE ROUGHENING STAIR STEPPING/GROOVING SLOPES

### 4.3 Sediment Control Best Management Practices

Once soil erosion occurs, sediment trapping or removal techniques can reduce the amount of sediment and associated pollutants that leave the site, thus protecting nearby streams, wetlands, and lakes. Sediment controls are usually placed around the perimeter of a disturbed area and where concentrated water leaves the site. Sediment controls are the last line of protection for a site and should be used in conjunction with other site controls. Sediment control BMPs should be in place before land clearing and grading begins. It is important to note that sediment controls, if poorly maintained, can become sources of sediment and other pollutants during larger storms.

1. Bio-filter Bags
2. Construction Entrance
3. Dewatering
4. Filter Berm
5. Inlet Protection
6. Oak Mats
7. Pre-Fabricated Barriers
8. Sand Bags
9. Sediment Basin
10. Sediment Fence
11. Sediment Trap
12. Sidewalk Subgrade Gravel Barrier
13. Tire Wash
14. Wattles

This page intentionally left blank.



# BIO-FILTER BAGS



### 4.3.1 Bio-filter Bags

Biofilter bags are used to minimize the transport of sediment from a construction site by providing a temporary physical barrier to sediment and reducing runoff velocities. Typically manufactured from 100% recycled wood-product waste placed in plastic mesh bags. May also be used for inlet protection, refer to section 4.3.5 in this manual.

#### Advantages

- Relatively low cost.
- Can be used in place of sediment fences at toe of slope, with proper staking.
- Wood-product can be recycled or used on site when no longer needed.
- Installation is simple, can be done by hand.
- Bags are easy to move, replace and reuse on paved surfaces.
- Are good short-term solution in situations where minor concentrated flows are causing erosion.

#### Disadvantages

- Generally effective for only a few months.
- Can be easily damaged by construction equipment or by traffic in paved areas.
- Can become clogged with sediment and cease to filter runoff.
- If improperly installed can allow undercutting or end-flow.
- Not effective where water velocities or volumes are high.
- Lightweight, which results in higher buoyancy if not properly installed.
- Low sediment retention capacity may require frequent maintenance.

#### Design Criteria

- Bio-filter bags should be clean 100 percent recycled wood product waste. Standard size 10x8x30 inches, weight approximately 45 pounds, with ½ inch plastic netting.
- May be left in place or used as mulch once they have served their purpose.
- Surface area should be smooth prior to application.
- Use (2) 1x2 inch stakes per bag, driven 12 inches into ground.
- Ends of bags must be overlapped 6 inches to prevent piping between joints.

#### Inspection & Maintenance

- Check that stakes are secure and ends of bags are tightly overlapped. Check that undercutting or end-flow is not occurring.
- Inspect plastic mesh bags for tears.
- Remove sediment when 1/3 height of bag has accumulated.
- Replace damaged bags as needed.

This page intentionally left blank.

# CONSTRUCTION ENTRANCE



### 4.3.2 Construction Entrance

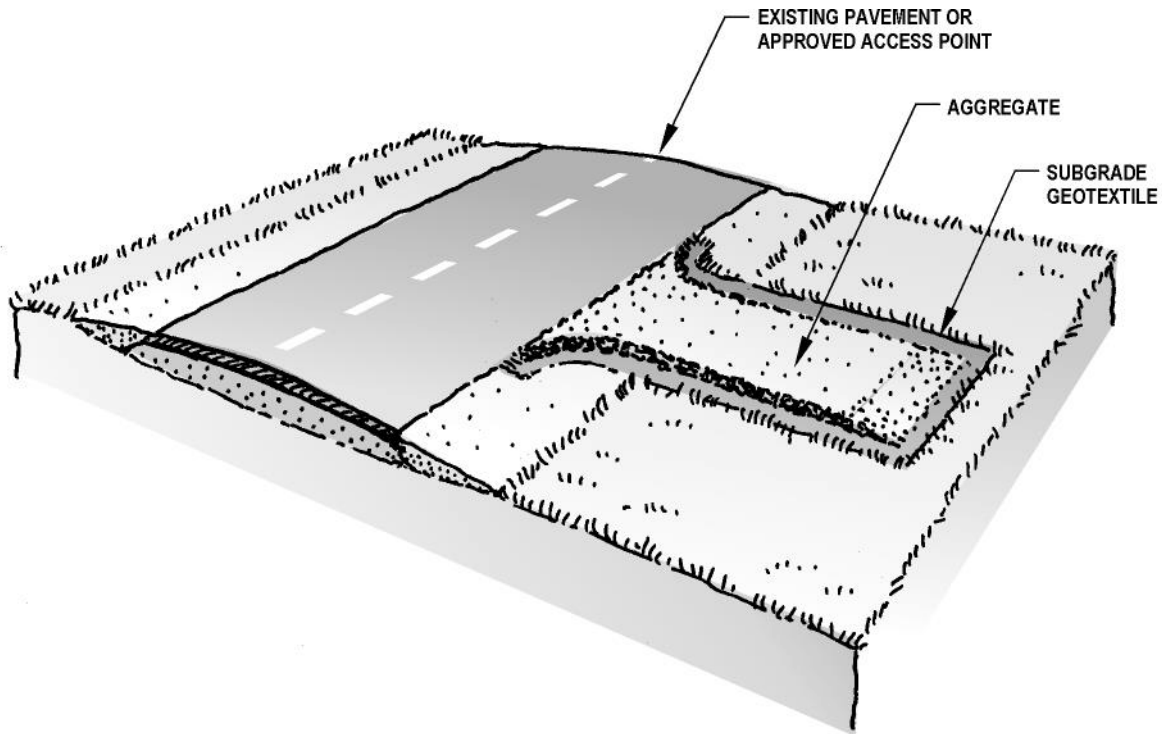

A construction entrance is a stabilized rock pad, placed at construction site ingress/egress locations to reduce the amount of sediment transported onto paved roads by vehicles or runoff. The construction entrance may also include a curb ramp designed out of wood.

#### Advantages

- Reduces traffic hazards caused by debris on public roadways.
- Reduces sediment and other debris from entering roadways, which can then be washed into the storm system.

#### Disadvantages

- Only effective if erosion and sediment control employed elsewhere onsite.
- Only effective if installed at every location where significant construction traffic leaves the site.
- Can fill with sediment quickly and require frequent maintenance and/or replacement of rock. In some cases may require the installation of a tire wash.

#### Design Criteria

- Install construction entrance prior to any site work.
- Whenever possible, construct the pad on a firm, compacted subgrade.

## CHAPTER 4: EROSION AND SEDIMENT CONTROL MEASURES AND BMPs

---

- Install geotextile under rock when subgrade is not stable or is “pumping” up into the pad.
- **Minimum length:**
  - 20 ft. – all single family sites.
  - 50 ft. – all other development sites.
- **Minimum width:**
  - 20 ft. – all construction sites.
- **Minimum Depth:**
  - 8 in. – all construction sites.
- **Rock Size:**
  - ¾” x 0 - all single family sites
  - 3-6 in. – all other construction sites
- Do not install rock on paved surfaces. (Use wood curb ramps.)
- Use clean rock only.
- Wood curb ramps should be made out of 2x6 material, nailed together.
- Include a tire wash facility if the entrance does not prove effective in retaining sediment onsite.

### Inspection & Maintenance

- Requires ongoing inspection.
- Immediately sweep up and remove or stabilize onsite any sediment that is tracked onto pavement.
- If the sediment poses a threat to public safety and street sweeping proves ineffective, consider washing the street and collecting the water in a sediment pond or sump before it leaves the site.
- Add or replace rock as needed to maintain the specified dimensions.
- Immediately remove any rock, which is carried from the pad to the roadway.

FOR FURTHER INFORMATION  
ON DESIGN CRITERIA SEE  
CHAPTER 4 OF EROSION  
PREVENTION AND SEDIMENT  
CONTROL PLANNING AND  
DESIGN MANUAL.

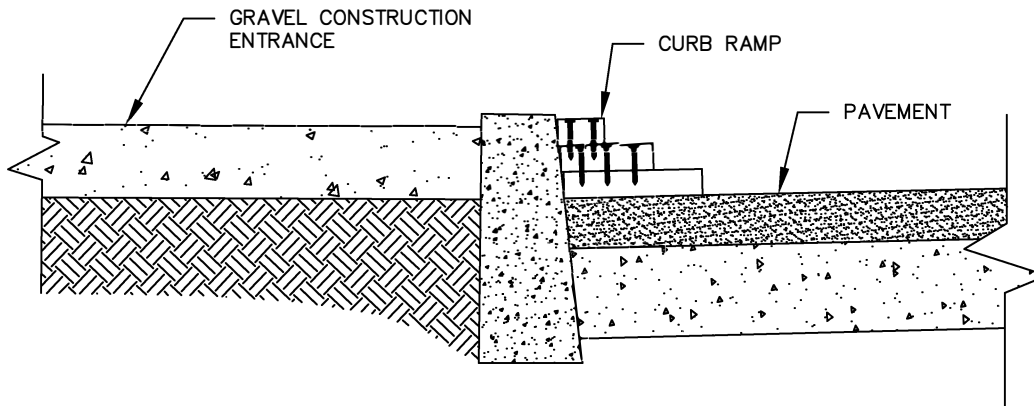
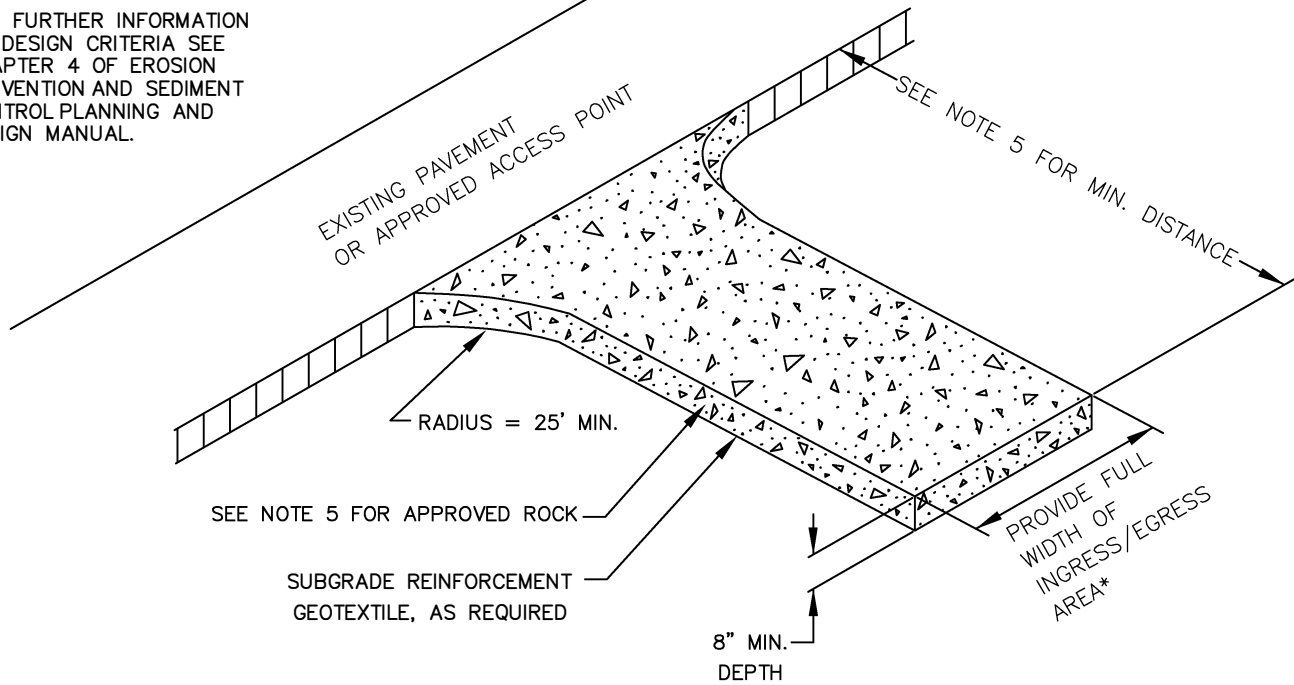

NOTES:

1. THE ENTRANCE SHALL BE MAINTAINED IN A CONDITION THAT WILL PREVENT TRACKING OR FLOWING OF SEDIMENT ONTO PUBLIC RIGHT-OF-WAYS. THIS MAY REQUIRE TOP DRESSING, REPAIR AND/OR CLEAN OUT OF ANY MEASURES USED TO TRAP SEDIMENT.
2. WHEN NECESSARY, WHEELS SHALL BE CLEANED PRIOR TO ENTRANCE ONTO PUBLIC RIGHT-OF-WAY.
3. WHEN WASHING IS REQUIRED, IT SHALL BE DONE ON AN AREA STABILIZED WITH CRUSHED STONE THAT DRAINS INTO AN APPROVED SEDIMENT TRAP OR SEDIMENT BASIN.
4. WHERE RUNOFF CONTAINING SEDIMENT LADEN WATER IS LEAVING THE SITE VIA THE CONSTRUCTION ENTRANCE, OTHER MEASURES SHALL BE IMPLEMENTED TO DIVERT RUNOFF THROUGH AN APPROVED FILTERING SYSTEM.
5. DIMENSIONS  
SINGLE FAMILY  
 20' LONG BY 20' WIDE 8" DEEP OF 3/4" MINUS CLEAN ROCK.  
COMMERCIAL/SITE DEVELOPMENT  
 50' LONG BY 20' WIDE 3-6" CLEAN ROCK, GOVERNING AUTHORITY MAY REQUIRE GEOTEXTILE FABRIC TO PREVENT SUB-SOIL PUMPING.

# CONSTRUCTION ENTRANCE

# DEWATERING





### 4.3.3 Dewatering

Dewatering operations are common on construction sites that encounter groundwater or other water that needs to be filtered prior to off-site discharge. This section assumes that material is uncontaminated groundwater. Filtration is the separation of sediment from a fluid by passing the fluid through a permeable medium that will trap a high percentage of the particles. The equipment necessary for filtration applications associated with water containing sediment includes weir tanks, gravity boxes, non-contained sediment bags, sand media filtration, Chitosan or other flocculants and bag/cartridge chambers. There are two types of filtration systems, gravity and pressure.

#### Advantages

- Excellent for utility work such as repairs, replacements, or new installations.
- Depending upon the choice of filtration systems, can remove small particles of silt and clays.
- Can be used as an alternate to sediment trap/basin on smaller sites.
- Can hold large amounts of sediment, which reduces overall maintenance.
- Can be used in conjunction with other types of filters as a pre-filter.
- Can be easily mobilized from site to site.

#### Disadvantage

- Can have limited storage capacity depending upon the site.
- Can have limited ability to remove silts and clays, depending upon the dewatering system.
- May require heavy equipment to load and unload system.
- May be cost prohibitive.

#### Design Criteria

- Determine soil type prior to selecting type of dewatering system.
- Select an appropriate location to place system that will reduce overall impacts.
- If removing large particles such as sand, weir tanks, and filter boxes are effective.
- If removing smaller particular such as silt and clay, Cartridge Filter Units and Chitosan can be effective.
- Filter bags can remove large particles until fabric pores start to fill in or cake over then filter capacity increases to smaller sand and silt.
- Filter bags that are used to dewater should be placed in a heavily vegetated area to increase their efficiency.

## CHAPTER 4: EROSION AND SEDIMENT CONTROL MEASURES AND BMPs

---

- Rock berms, bio-filter bags, can be installed as an alternate, or in conjunction with other systems.

### Inspection & Maintenance

- Ongoing inspection is necessary in order to detect any malfunctions or operation of equipment.
- Periodic inspection of discharge areas.
- Inspection protocol for use of Chitosan must be followed. Refer to state and local jurisdiction for requirements.
- Remove sediment when it reaches 1/3 capacity of a sediment barrier.
- Material must be placed in an approved location on site or exported from site.

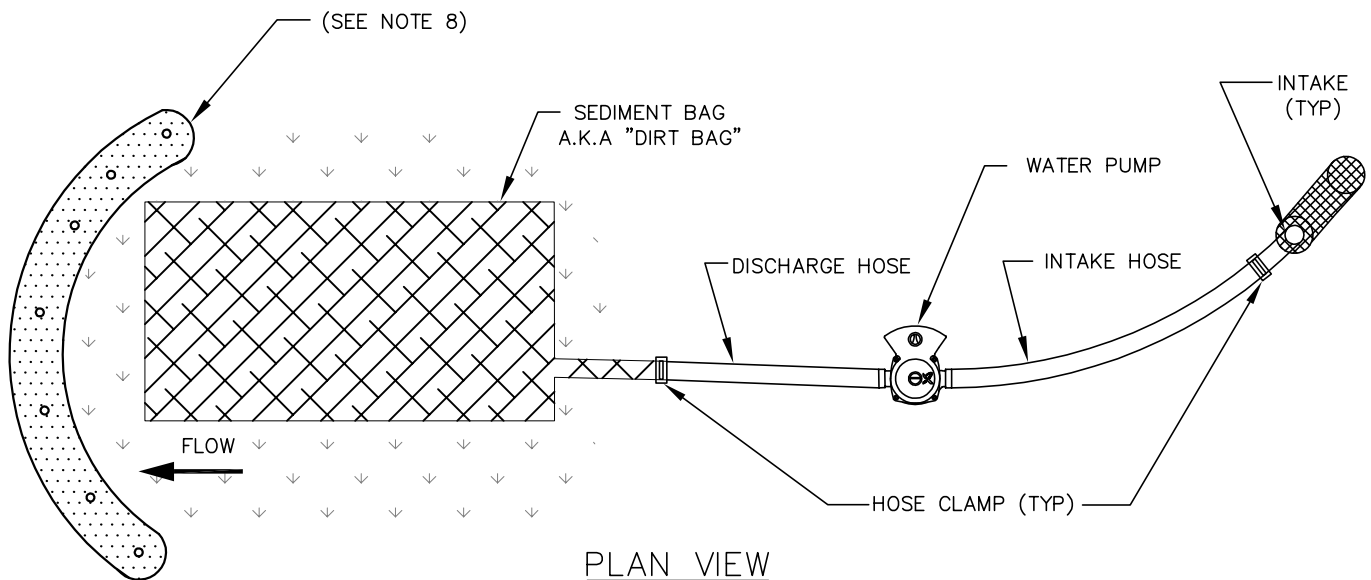

NOTES:

1. THE SEDIMENT BAG SHALL BE MANUFACTURED USING A POLYPROPYLENE 8 OZ. NON-WOVEN GEOTEXTILE SEWN INTO A BAG WITH A DOUBLE NEEDLE, USING A HIGH STRENGTH THREAD.
2. EACH STANDARD SEDIMENT BAG MUST HAVE A FILL SPOUT LARGE ENOUGH TO ACCOMMODATE A 4" DISCHARGE HOSE. STRAPS ARE ATTACHED TO SECURE THE HOSE AND PREVENT PUMPED WATER FROM ESCAPING WITHOUT BEING FILTERED.
3. THE SEDIMENT BAG SHALL MEET OR EXCEED OVERALL BAG REMOVAL EFFICIENCY RATE OF 97.55%.
4. WATER BEING DISCHARGED FROM THE SEDIMENT BAG MUST BE FREE OF ALL SEDIMENT PRIOR TO LEAVING THE SITE OR ENTERING INTO THE STORM SYSTEM.
5. SEDIMENT BAG IS FULL WHEN IT NO LONGER CAN EFFICIENTLY FILTER SEDIMENT OR ALLOW WATER TO PASS AT A RATE LESS THAN 50% OF MANUFACTURER'S DESIGNED FLOW RATE.
6. DURING USE, THE SEDIMENT BAG MUST BE MONITORED.
7. DISPOSE OF USED SEDIMENT BAG OFF SITE OR AS APPROVED BY CWS.
8. WHEN APPROPRIATE, INSTALL DOWNSTREAM SEDIMENT CONTROL MEASURES PER CWS STANDARDS.
9. FOR BEST RESULTS, PLACE SEDIMENT BAG ON FLAT SURFACE.
10. SEDIMENT BAG SHOULD BE PLACED ON EXISTING VEGETATION, ROCK, OR BED OF STRAW. SEDIMENT BAG SHOULD NOT BE PLACED ON BARE GROUND.

# SEDIMENT BAG

DRAWING NO. 4-30

REVISED 10-31-19

This page intentionally left blank.

# FILTER BERM



### 4.3.4 Filter Berm

A filter berm is intended to control erosion and sedimentation by reducing the rate of surface runoff. Filter berms can be composed of aggregate or compost.

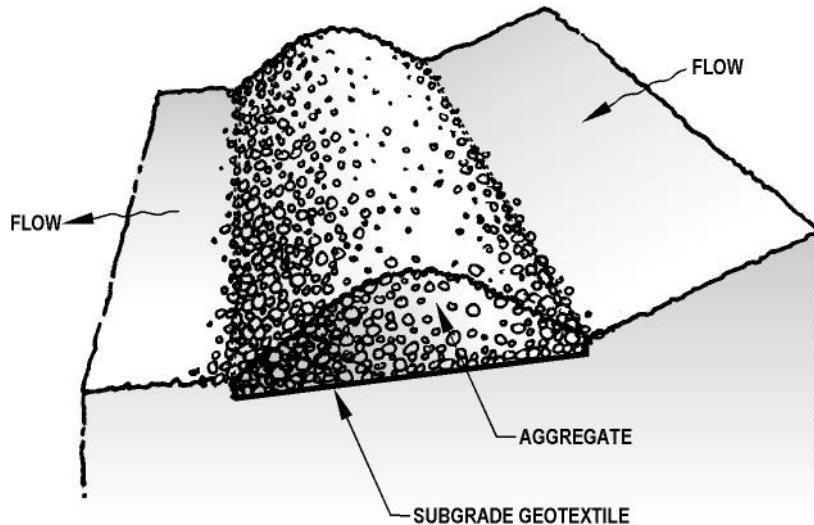

**AGGREGATE BERM** - Retains sediment in gravel or crushed rock berm.

#### Advantages

- Very efficient method for sediment removal.
- Reduces runoff velocity.

#### Disadvantages

- More expensive than some other measures because requires clean gravel or crushed rock rather than materials found onsite.
- Clogging from mud and soil may make maintenance difficult.
- Has a limited life span.

#### Design Criteria

- Use 6 inch. maximum washed and well-graded gravel or crushed rock with less than 5% fines.
- Berm Dimensions:
  - ❑ Height and side slopes: 1 foot high with 3:1 side slopes.
  - ❑ Length: 8 foot per 1 cubic foot per second flow, based on the peak flow for the 10-year storm.
  - ❑ If used as slope application, use Table 4-8 for spacing requirements.
  - ❑ Used primarily as a base measure (toe of slope)

**Table 4-8 Barrier Spacing For General Applications**

INSTALL PARALLEL ALONG CONTOURS AS FOLLOWS		
% Slope	Slope	Maximum Spacing on Slope
10 % Flatter	10:1 or Flatter	300 ft
10 > % < 15	10:1 > x < 7.5:1	150 ft
15 > % < 20	7.5:1 > x < 5:1	100 ft
20 > % < 30	5:1 > x < 3.5:1	50 ft
30 > % < 50	3.5:1 > x < 2:1	25 ft

**COMPOST BERM** - Can be used in place of sediment fence, straw wattles, compost sock, etc. (For sheet flow only.)

Advantages

- Very efficient method for sediment removal.
- Reduces runoff velocity.
- Compost retains a large volume of water.
- The mix of particle sizes in the compost filter material retains as much or more sediment than traditional perimeter controls, such as sediment fences, while allowing a larger volume of clear water to pass through the berm.
- Low removal cost as compost berm can be spread/tilled into surface as a soil amendment when no longer needed or can be seeded and left in place.

Disadvantages

- Initial cost may be higher than some other more commonly used measures.
- Clogging from mud and soil may make maintenance difficult.
- Has a limited life span.

Design Criteria

- Use mature, good quality material with sufficient particle size distribution. .
- Berm Dimensions:
  - Height and side slopes: 1 -1.5 feet high and 2-3 ft width at base.
  - If used as slope application, use Table 4-9 for spacing requirements.
  - To be used solely for sheet flow and installed along contours of slope

## CHAPTER 4: EROSION AND SEDIMENT CONTROL MEASURES AND BMPs

Table 4-9 Compost Berm Spacing and Minimum Dimensions

Slope	Slope Length	Min. Berm Dimensions (height x width)
<50:1	250 ft	1 ft x 2 ft
50:1 - 10:1	125 ft	1 ft x 2 ft
10:1 - 5:1	100 ft	1 ft x 2 ft
3:1 - 2:1	50 ft	1.3 ft x 2.6 ft
>2:1	25 ft	1.5 ft x 3 ft

### Inspection & Maintenance

#### Aggregate Berm

- Remove and replace rock when filtering capacity is reduced by half to maintain performance.
- Remove sediment accumulation when it reaches one-third of the barrier height.

#### Compost Berm

- Check for under-cutting or piping under berm.
- Inspect for channel formation parallel to the berm, which indicates it is acting as a flow barrier.
- Immediately repair any damage and install additional berms as needed.
- Remove sediment accumulation when it reaches one-third of the barrier height.



FOR FURTHER INFORMATION  
ON DESIGN CRITERIA SEE  
CHAPTER 4 OF EROSION  
PREVENTION AND SEDIMENT  
CONTROL PLANNING AND  
DESIGN MANUAL.

NOTES:

1. DIRECT THE OUTLET SIDE OF THE ROCK/COMPOST FILTER BERMS ONTO A STABILIZED AREA, SUCH AS VEGETATION AND/OR ROCK.
2. EMBED ROCK FILTER BERM A MIN. OF 4" INTO THE EXISTING GROUND/EMBANKMENT.
3. USE ROCK FILTER BERM ON 3H:1V OR FLATTER SIDE SLOPES. WITHIN THE SAFETY CLEAR ZONE. USE 6H:1V OR FLATTER ON SIDE SLOPES.
4. PLACE COMPOST FILTER BERMS ALONG OR ON THE GROUND CONTOUR WITH THE ENDS TURNED UP SLOPE.
5. PRIOR TO INSTALLING A COMPOST FILTER BERM IN A VEGETATED AREA, ENSURE THAT THE VEGETATION IS CUT TO A HEIGHT OF NO GREATER THAN 3" PRIOR TO INSTALLATION.
6. COMPOST HAS NOT BEEN CHEMICALLY TREATED AND IS WEED-FREE, PLASTIC-FREE, DECOMPOSED, NON-WOODY PLANT MATERIAL; ANIMAL WASTE IS NOT ALLOWED.

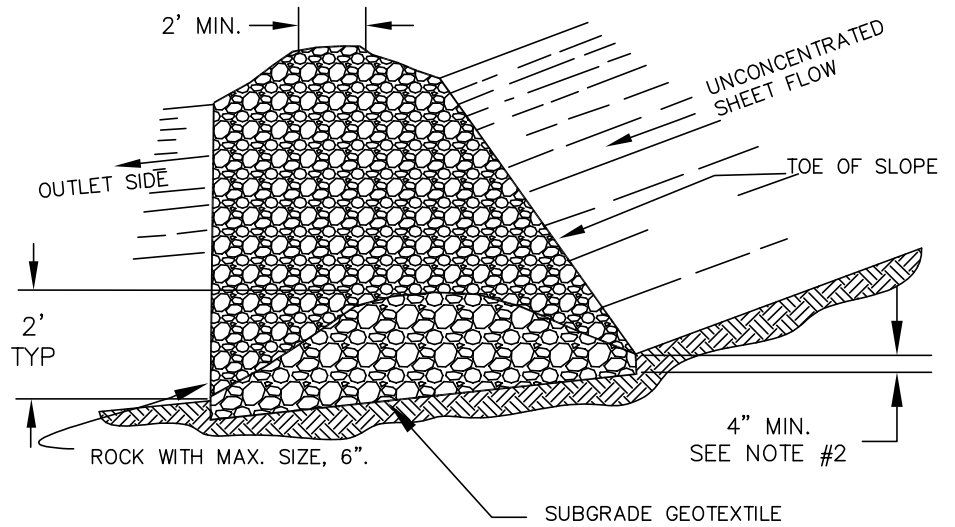

ROCK FILTER BERM

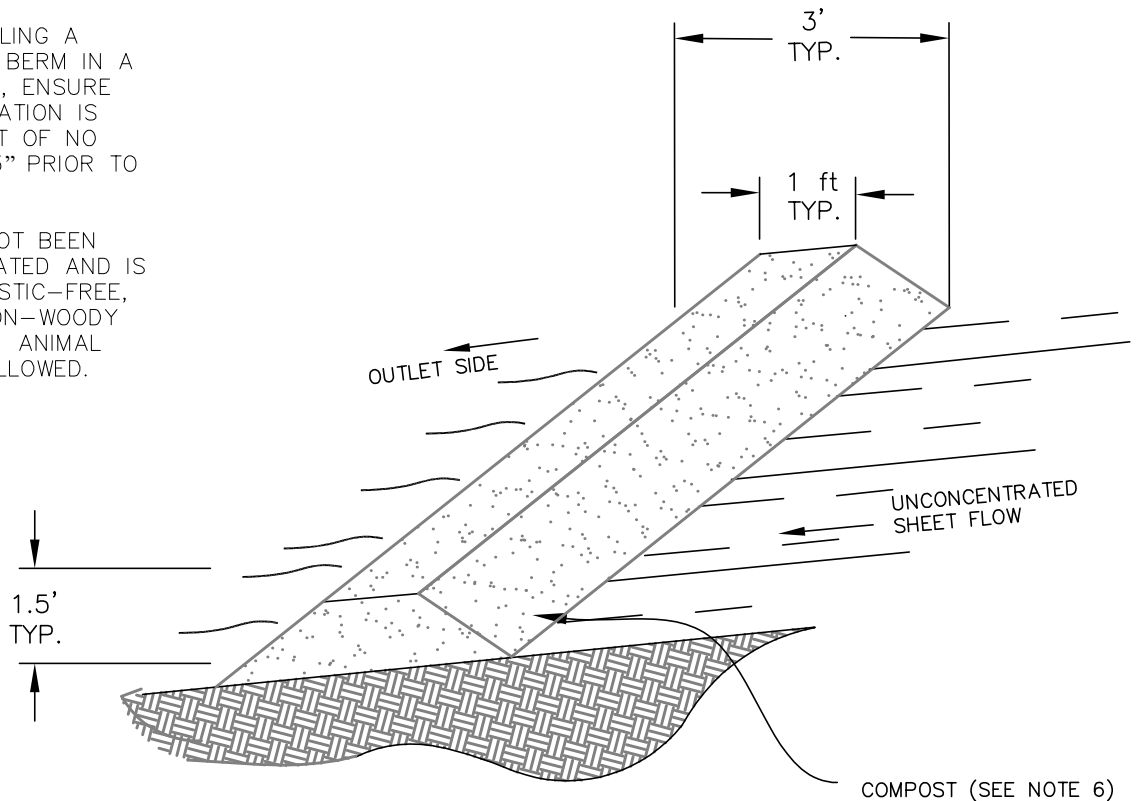

COMPOST FILTER BERM

FILTER BERMS  
ROCK/COMPOST

# INLET PROTECTION

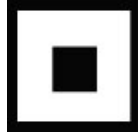

### 4.3.5 Inlet Protection

Inlet protection prevents coarse sediment from entering storm drainage systems by filtering runoff and retaining sediment before it reaches a drainage inlet or storm sewer system. There are many options and variations of inlet protection available.

Inlet Protection – Masonry / Aggregate

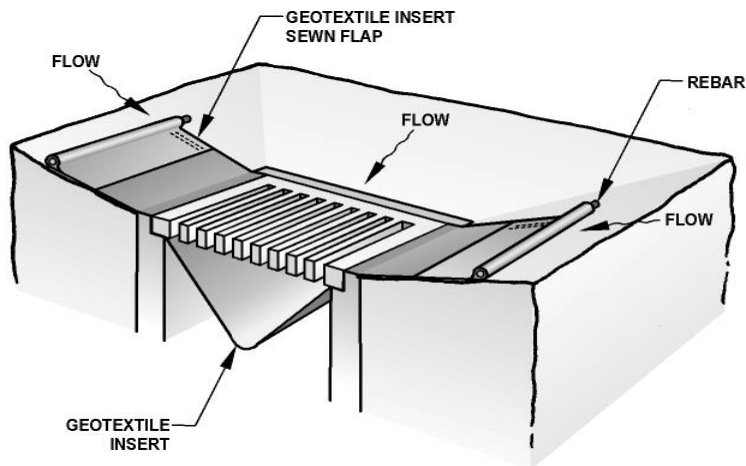

Inlet Protection - Prefabricated Filter Insert

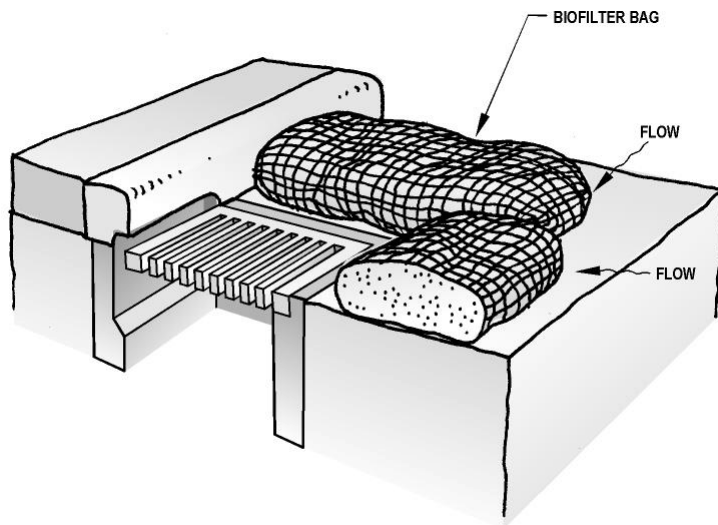

Inlet Protection – Biofilter Bags Around Catch Basin

## CHAPTER 4: EROSION AND SEDIMENT CONTROL MEASURES AND BMPs

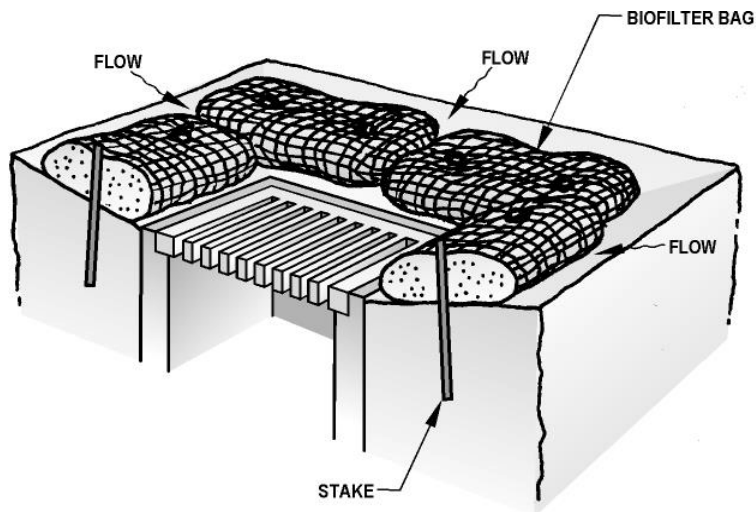

Inlet Protection – Biofilter Bags around Area Drain

### Advantages

- Prevents sediment from entering the storm drain system.
- Reduces amount of sediment leaving the site.

### Disadvantages

- May result in ponding of water above the catch basin.
- Sediment removal may be difficult under high-flow conditions.
- May result in a traffic hazard.
- Short-circuiting of flow may occur if not properly installed.
- Useful only for low flows having low sediment loading.
- Improper installation, maintenance or removal may introduce sediment into the storm drain system.

### Design Criteria

- Place at all inlets down gradient of construction activities.
- Place inlet protection in areas where water can pond, and where ponding will not have adverse impacts.
- Inlet protection must allow for overflow in a severe storm event.
- Addition measures must be considered depending upon soil type
- Inlet protection types include:
  - Type 3 - Filter Fabric
  - Type 4 - Biofilter bags
  - Type 5 - Catch basin insert
  - Type 6 – Bone bags

## CHAPTER 4: EROSION AND SEDIMENT CONTROL MEASURES AND BMPs

---

### Inspection & Maintenance

- Clean inlet protection during and after each significant storm and remove sediment from behind structure after every storm.
- If the rock becomes clogged with sediment, it must be carefully removed from the inlet and either cleaned or replaced.
- Assess the impacts of allowing water to pond at the inlet and provide an overflow weir or some other type of relief as needed.
- Use mechanical means to remove sediment deposits (shovel, broom, sweeper/vactor unit).
- Remove sediment accumulated on or around the protection as needed to maintain intended functions.
- Repair or replace materials as needed to ensure proper functioning.
- Remove inlet protection when construction activity is complete.

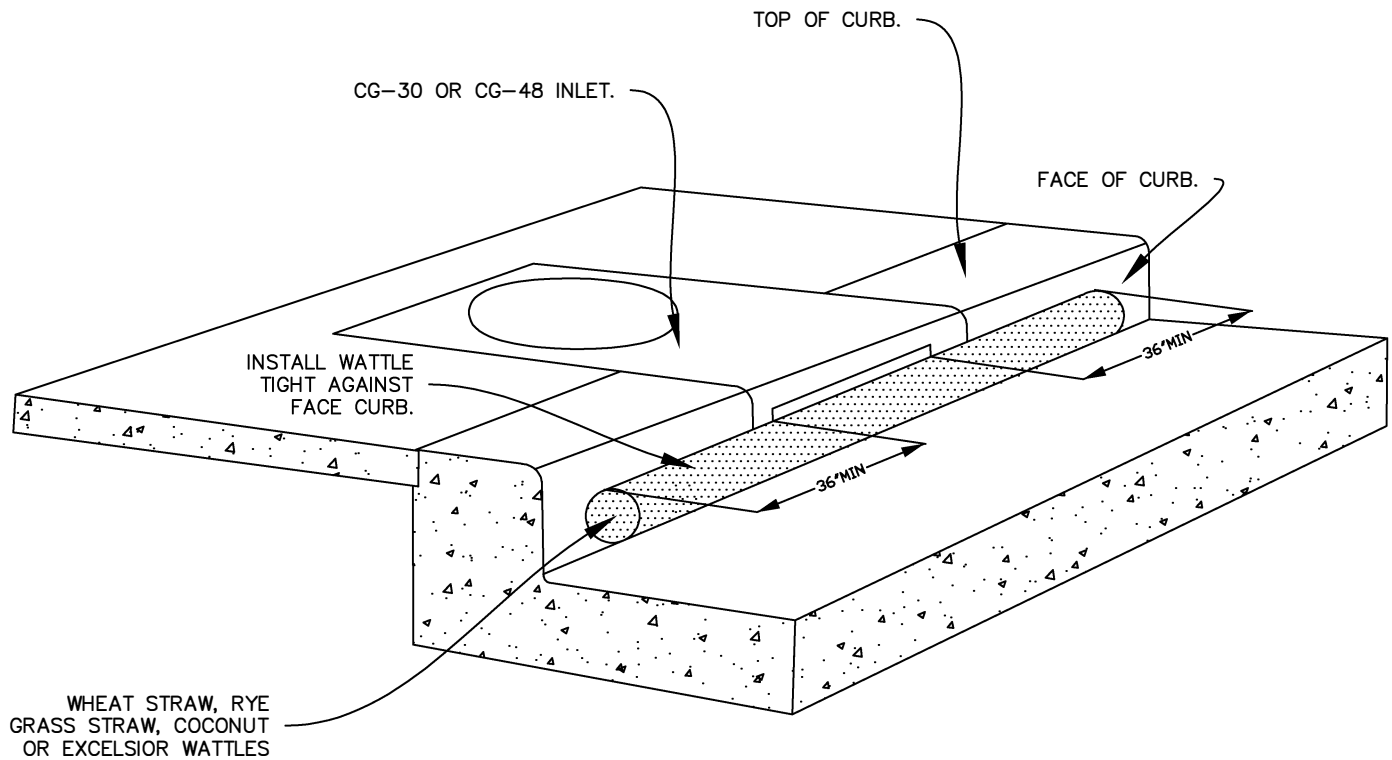

PERSPECTIVE VIEW SHOWING WATTLE  
ALONG GUTTER AT CURB INLET.

NOTES:

1. ONLY ALLOWED USE OF APPLICATION IS ON CURB AND GUTTER INLETS.
2. INSTALL WATTLE ALONG INLET WITH WATTLE EXTENDING A MIN OF 36" BEYOND INLET OPENINGS IN EACH DIRECTION.
3. WATTLE MUST BE INSTALLED TIGHTLY AGAINST CURB. MAY REQUIRE ADDITIONAL MEASURES TO ENSURE WATTLE REMAINS TIGHT AGAINST CURB, SUCH AS USING ZIP TIES TO SECURE WATTLE TO INLET'S TRASH BARS OR USING SANDBAGS TO WEIGHT DOWN WATTLE.
4. REPLACE WATTLE AS NECESSARY TO PREVENT SEDIMENT FROM ENTERING THE STORM SYSTEM.

CURB AND GUTTER  
INLET PROTECTION

DRAWING NO. 4-21

REVISED 10-31-19

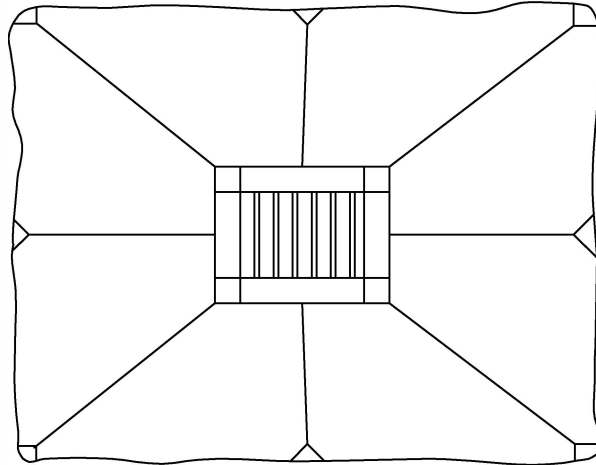
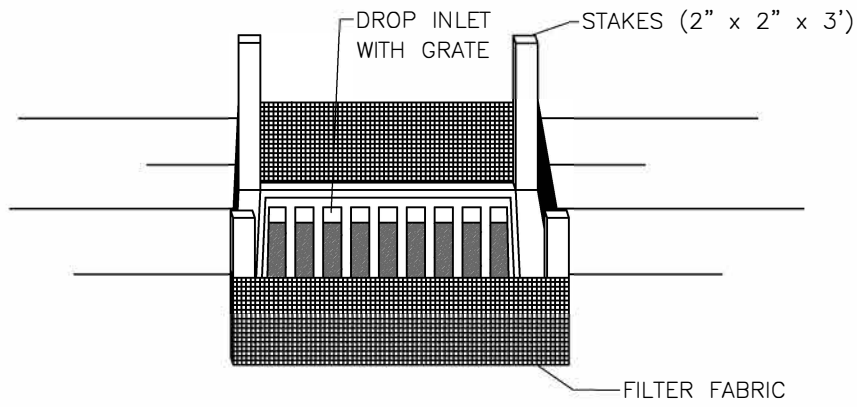

PLAN VIEW  
Slope 4H:1V

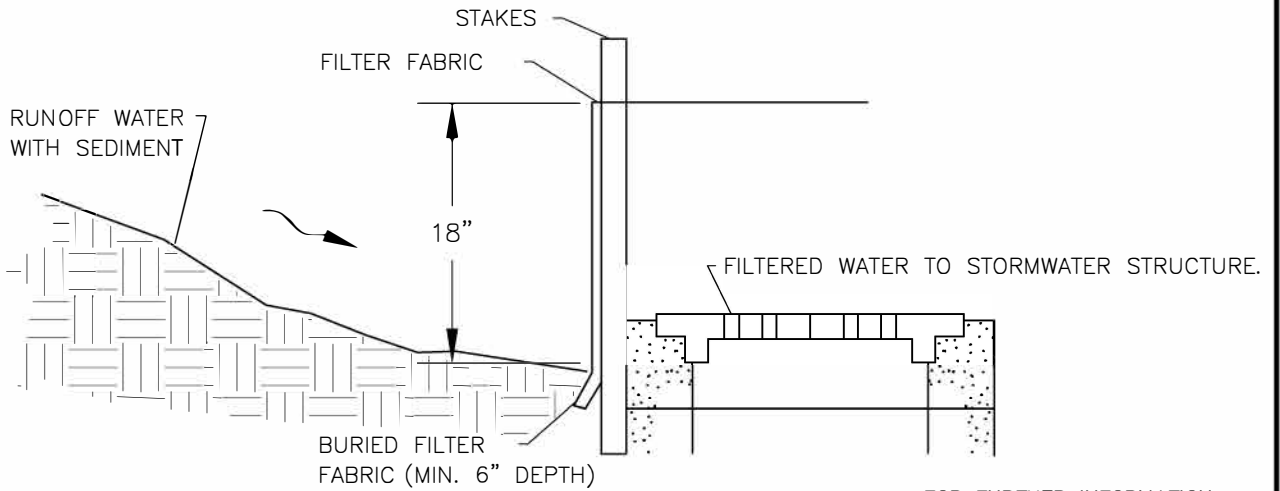
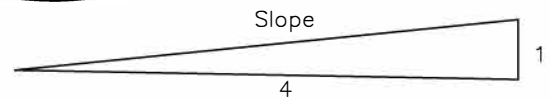

PROFILE

FOR FURTHER INFORMATION  
ON DESIGN CRITERIA SEE  
CHAPTER 4 OF EROSION  
PREVENTION AND SEDIMENT  
CONTROL PLANNING AND  
DESIGN MANUAL.

# INLET PROTECTION TYPE 3

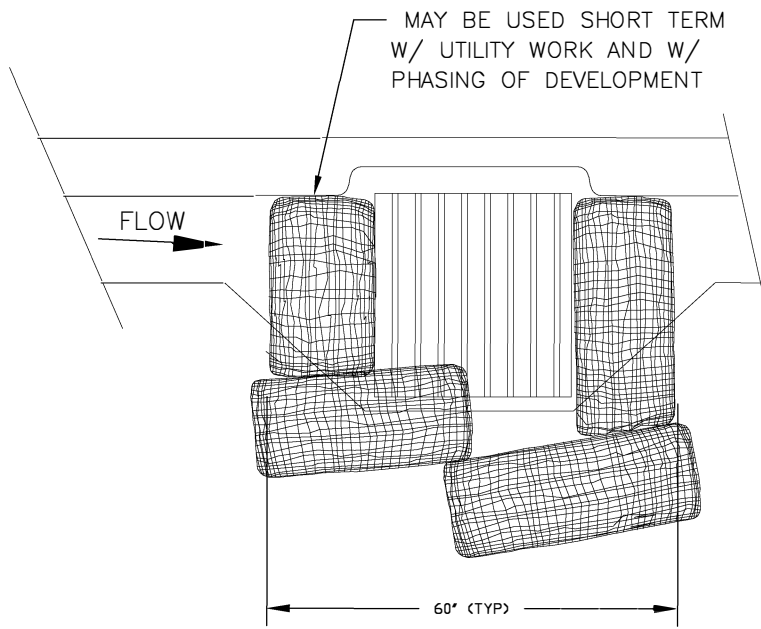

CATCH BASIN

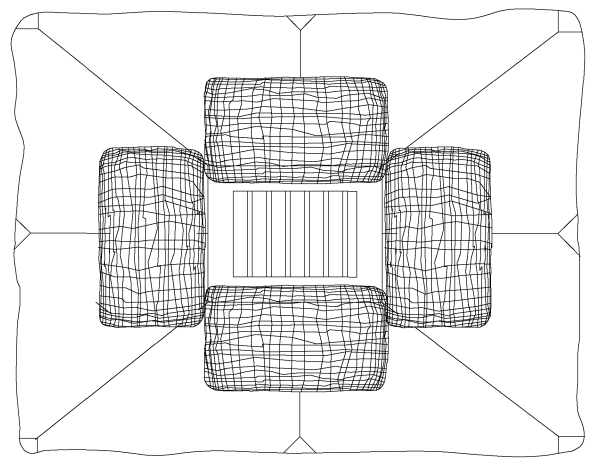

AREA DRAIN

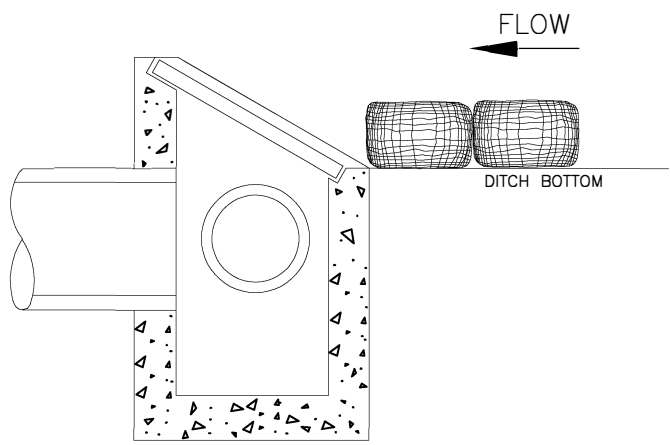

DITCH INLET

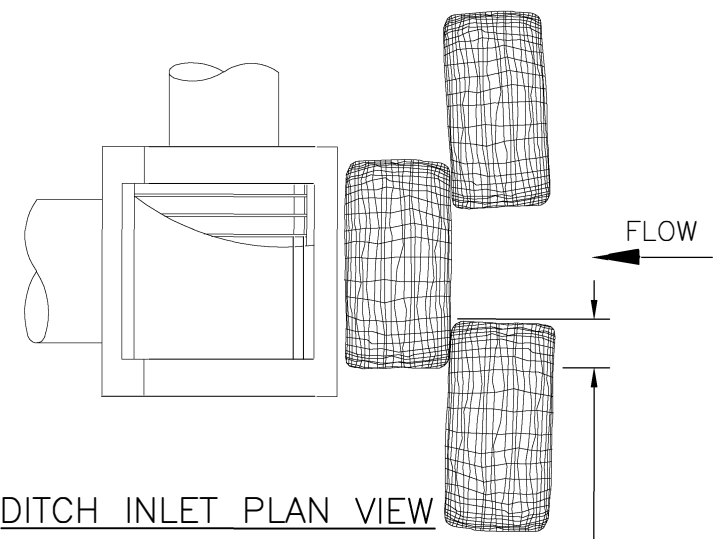

DITCH INLET PLAN VIEW

6" overlap of bags.

NOTES:

1. ADDITIONAL MEASURES MUST BE CONSIDERED DEPENDING ON SOIL TYPES.
2. BIO-FILTER BAGS SHOULD BE STAKED WHERE APPLICABLE USING (2) 1"x2" WOODEN STAKES OR APPROVED EQUAL PER BAG.
3. WHEN USING 30" BIO-BAGS TO PROTECT A CATCH BASIN YOU HAVE 4 BAGS AND THEY SHALL BE OVERLAPPED BY 6".

FOR FURTHER INFORMATION ON DESIGN CRITERIA SEE CHAPTER 4 OF EROSION PREVENTION AND SEDIMENT CONTROL PLANNING AND DESIGN MANUAL.

# INLET PROTECTION TYPE 4



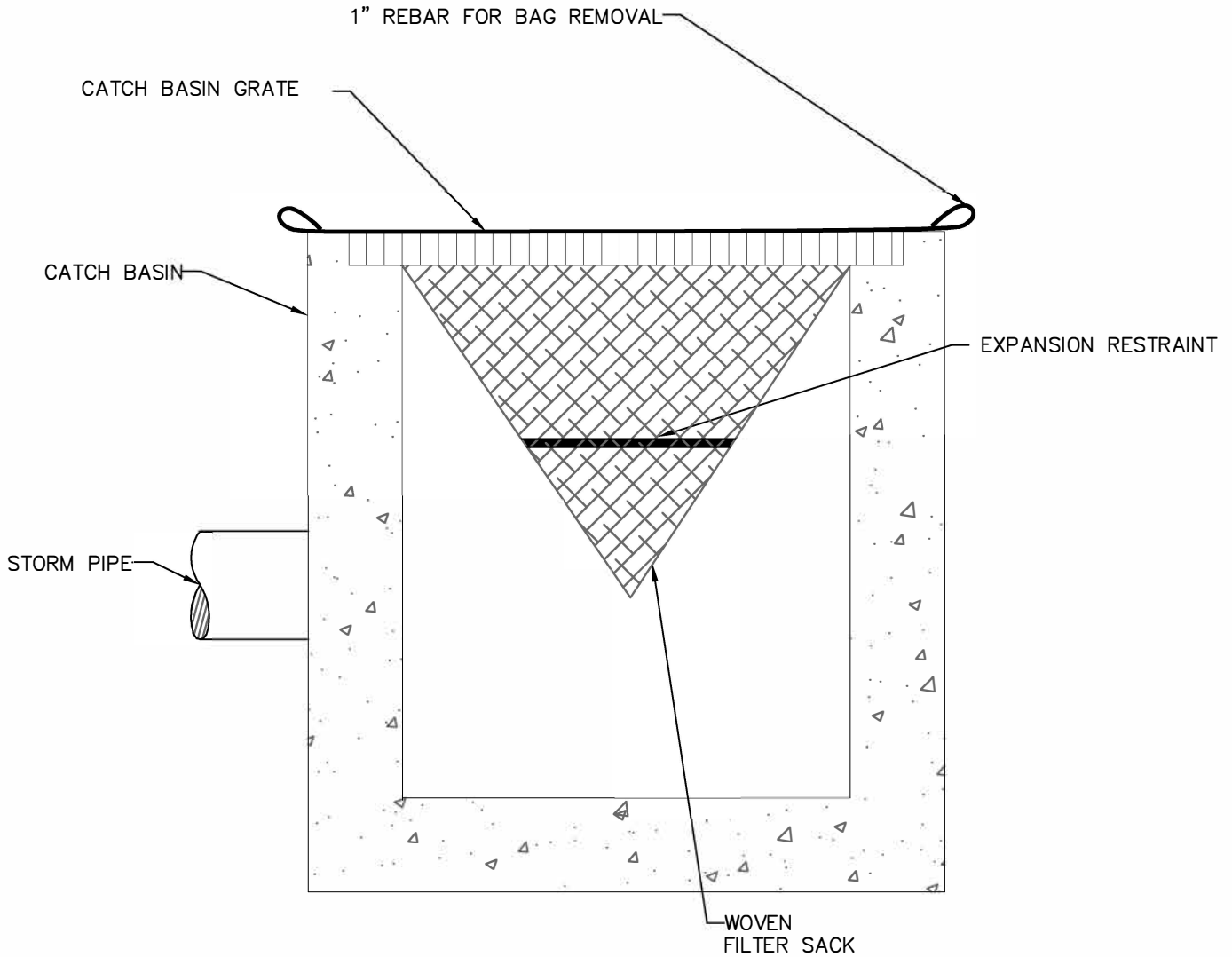

CATCH BASIN INSERT

NOTE:

1. RECESSED CURB INLET CATCH BASINS MUST BE BLOCKED WHEN USING FILTER FABRIC INLET SACKS. SIZE OF FILTER FABRIC INLET SACKS TO BE DETERMINED BY MANUFACTURER.

FOR FURTHER INFORMATION ON DESIGN CRITERIA SEE CHAPTER 4 OF EROSION PREVENTION AND SEDIMENT CONTROL PLANNING AND DESIGN MANUAL.

INLET PROTECTION  
TYPE 5

FOR FURTHER INFORMATION  
ON DESIGN CRITERIA SEE  
CHAPTER 4 OF EROSION  
PREVENTION AND SEDIMENT  
CONTROL PLANNING AND  
DESIGN MANUAL.

MAY BE USED SHORT TERM W / UTILITY  
WORK AND W / PHASING OF DEVELOPMENT

TIGHT TO CURB

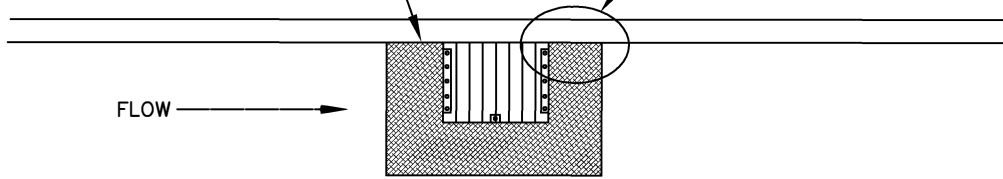

CATCH BASIN



FRONT

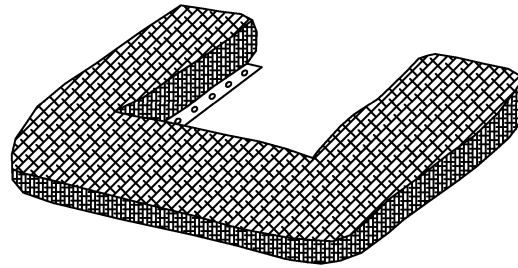

GROMMETS USED FOR  
ATTACHMENT TO GRATE

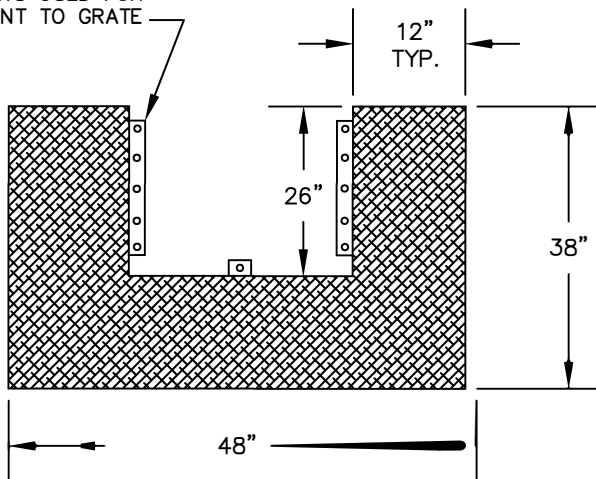

TOP

INSTALLATION NOTES:

1. INSTALL SOLID FABRIC SIDE DOWN MESH SIDE UP.
2. ATTACH TO CATCH BASIN GRATE AT A MINIMUM OF 3 LOCATIONS TIGHT TO CURB WITH 1/4" ZIP TIES.

MAINTENANCE NOTES:

1. ANY VISIBLE SIGN OF SEDIMENT ACCUMULATION TO BE CLEANED UP AT THE END OF EACH WORKDAY.
2. REPLACE U - SHAPED FILTER BAG AS NECESSARY TO PREVENT WOOD CHIPS FROM ENTERING THE STORM SYSTEM.

INLET PROTECTION  
TYPE 6

DRAWING NO. 4-25

REVISED 10-31-19

This page intentionally left blank.

# Oak Mats



### 4.3.6 Oak Mats

Oak mats are stabilized platforms, located at specified points of construction for the purpose of temporary or permanent ingress and egress. Oak mats have two benefits: reduce overall tracking from construction sites, and creates a stable pad for heavy equipment, especially when working around sensitive areas such as wetlands and streams.

#### Advantages

- Provides a solid working platform
- Reduces tracking
- Significantly lighter than conventional steel sheets
- Can be used several times
- Use lifting cables for easy of loading and unloading
- Excellent alternative for linear projects

#### Disadvantages

- Not suitable for all construction sites
- Depending upon the site, can be expensive
- Will deteriorate with age

#### Design Criteria

- Dimensions: 8' x 16' x 4 1/2" (3 Ply Laminated oak or equivalent)
- Built-in lifting cables at each end
- Used for temporary or permanent access
- Built to withstand heavy equipment such as cranes, dump trucks, and back hoes
- On linear projects, that parallel streams or wetlands install as a continuous working pad to reduce soil "pumping"
- Minor excavation of surface area may be required prior to installation of mats

#### Inspection & Maintenance

- Requires on-going inspection
- Remove any soil deposits from equipment and vehicles prior to driving on mats.
- Immediately sweep up and remove any material that has been tracked offsite.
- Remove and replace mats when they no longer stable or wood has become broken or separated
- Check lifting cables to make certain they are in working order

FOR FURTHER INFORMATION  
ON DESIGN CRITERIA SEE  
CHAPTER 4 OF EROSION  
PREVENTION AND SEDIMENT  
CONTROL PLANNING AND  
DESIGN MANUAL.

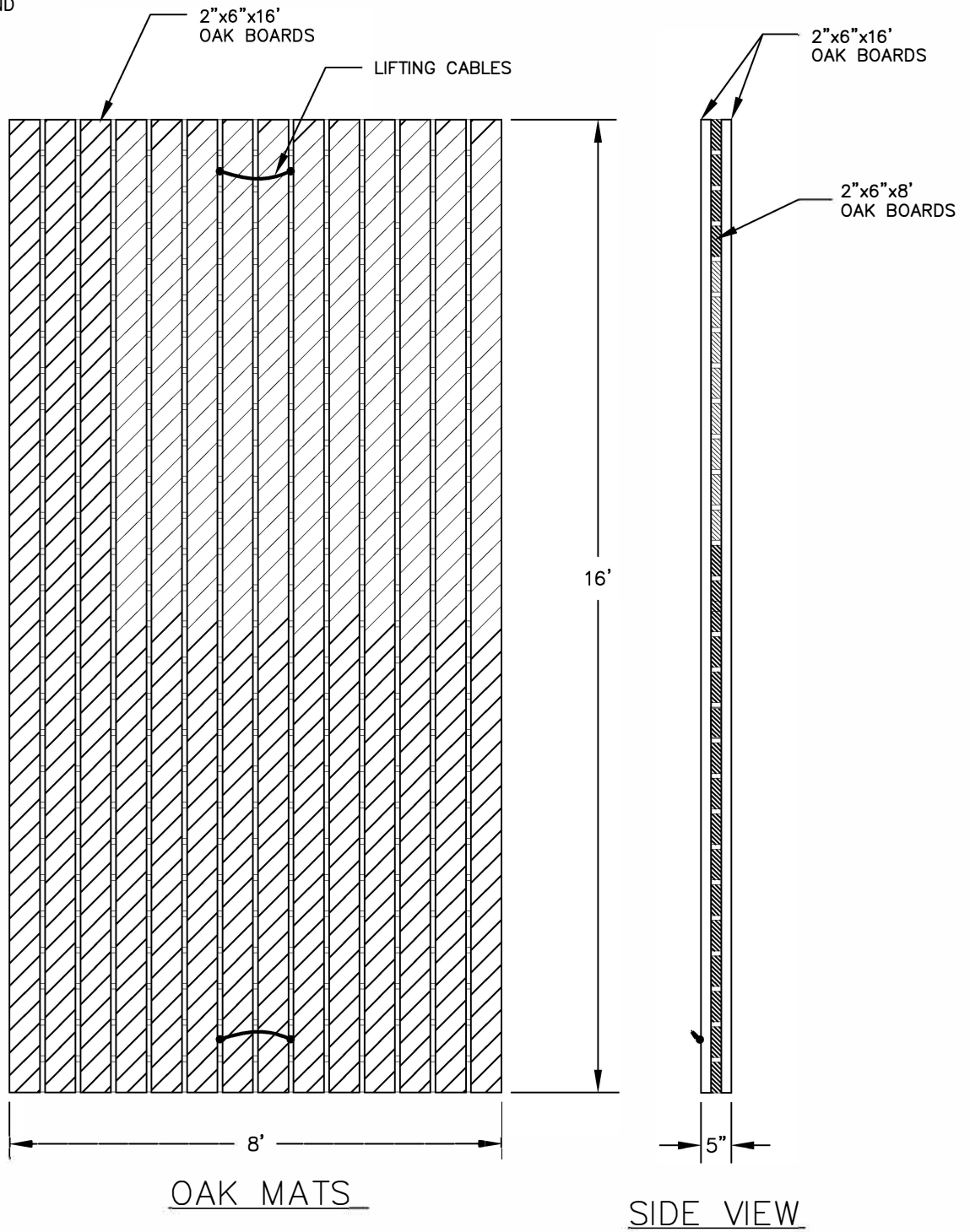

NOTES:

1. CONSTRUCTED OF 2"x6" OAK.
2. ALTERNATE MATTING SYSTEMS TO BE APPROVED BY CITY/DISTRICT.

# OAK MATS

This page intentionally left blank.

# PRE-FABRICATED BARRIER





### 4.3.7 Pre-Fabricated Barrier System

Pre-fabricated barrier systems typically consist of a triangular shaped dike, usually made of foam or other flexible, lightweight material. The dike is wrapped in geotextile, which extends from the bottom of the dike to provide aprons on the upslope and downslope sides of the dike. The dike is anchored by trenching and stapling the aprons. Barrier materials, section lengths and weights vary among manufacturers. Other pre-fabricated barriers consist of water filled hinged panels that act as a sediment basin or toe of slope base measure. The purpose of these systems is to hold run-off for designed periods of time in order to allow for settling of soil.

#### Advantages

- Can be lightweight.
- Installation is relatively simple.
- Can be used to divert and slow velocity of small drainage areas.
- Reusable.
- Can retain larger suspended soils particles.

#### Disadvantages

- The foam type can be easily damaged by construction equipment.
- Not effective in steep swales, channels or ditches.
- If improperly installed, can allow undercutting or end-flow.
- Not effective where water velocities or volumes are high.
- Installation must be done exactly as specified by manufacturer.
- Not intended for use on steep slope applications.

#### Design Criteria

- Used primarily as a base measure.
- Install in accordance with plans, special provisions and manufacturer's recommendations.
- Specify drainage area.

#### Inspection & Maintenance

- Check that undercutting or end-flow is not occurring.
- Check that barrier is not otherwise damaged.
- Check that aprons are securely anchored.
- Check that flow is not becoming channeled behind barrier (parallel to barrier),
- Remove sediment accumulation behind barrier when sediment reaches one-third the barrier height.
- Replace damaged sections as needed.

This page intentionally left blank.

# SAND BAGS



### 4.3.8 Sand Bags

Sandbags are manufactured from durable, weather resistant tightly woven Geotextile fabric material sufficient to prohibit leakage of the filler material. The bags should measure 24 x 12 x 6 inches and be filled with firmly packed sand weighing at least 75 lbs.

#### Advantages

- Relatively low cost.
- Installation is simple, can be done by hand.
- Bags are easy to move, replace and reuse on paved surfaces.
- Are a good short-term solution in situations where concentrated flows are causing erosion.
- Can be used to divert and slow velocity of small flows.
- Can be used in concrete lined ditches capture sediment and reduce water velocity.

#### Disadvantages

- Generally effective for only a few months.
- Can be easily damaged by construction equipment or by traffic in paved areas.
- Can contribute sediment to runoff if bags rupture.
- Cannot be staked and are not appropriate on steep slope applications.
- Not effective in steep swales, channels or ditches.
- If improperly installed, can allow undercutting or end-flow.
- Not effective where water velocities or volumes are high: can get washed away.

#### Design Criteria

- Generally used in ditches and/or swales as a check dam.
- Can be used on highway or road projects to divert run-off.
- Ends of bags must be tightly abutted and overlapped to direct flow away from bag joints.

## CHAPTER 4: EROSION AND SEDIMENT CONTROL MEASURES AND BMPs

---

### Inspection & Maintenance

- Check that ends of bags are tightly abutted. Check that undercutting or end-flow is not occurring.
- Remove sediment accumulated behind bags when sediment reaches one-third of the barrier height.
- Replace damaged bags as needed.

This page intentionally left blank.

# SEDIMENT BASIN



### 4.3.9 Sediment Basin

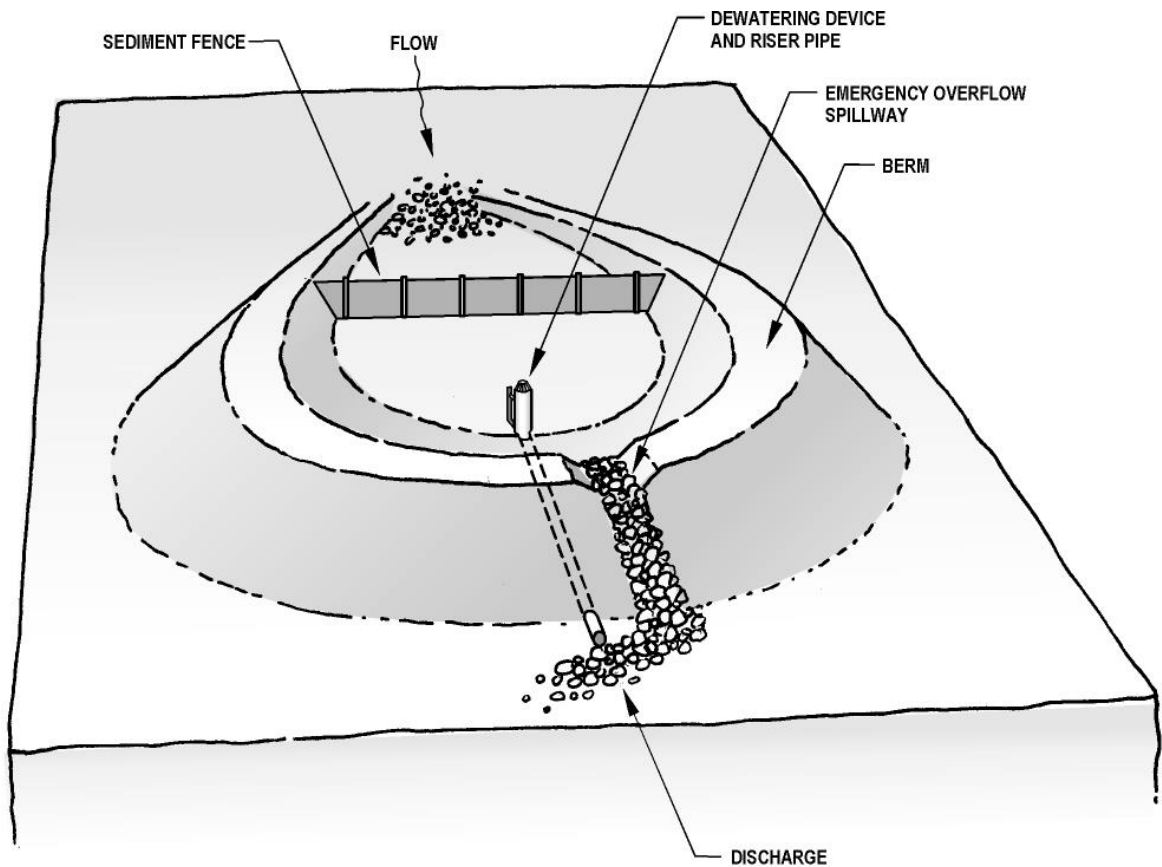

A temporary sediment basin has one or more inflow points and baffles to spread the flow, wet storage and dry storage, a securely anchored riser pipe, a dewatering device and an emergency overflow spillway. A sediment basin should serve a drainage area less than 10 acres in size and have a design life of approximately 1-year.

Basins are large facilities that treat runoff from large drainage areas. Because of this, basins have limited application on linear construction projects. The applications, advantages and disadvantages of basins are included here for the designer's edification.

#### Combining with Permanent Drainage Facilities

- If a project includes a permanent storm water retention/detention pond, the rough-graded or final-graded facility could function as a basin during construction. Design features of the permanent structure, such as surface area, retention time and outlet control, should meet the design requirements of the temporary facility.



## CHAPTER 4: EROSION AND SEDIMENT CONTROL MEASURES AND BMPs

---

Completion of the permanent facility should occur only when all upstream control structures are in place and stabilization of contributing drainage areas is complete.

- Sediment fence should be installed around perimeter to protect against potential breach.
- If a project includes an infiltration facility, the roughly excavated facility could be used as a basin, providing the facility provides the surface area and retention time required by the basin. Excavate the sides and bottom of the facility to a minimum of 2 foot above final grade with a backhoe working at “arms length” to minimize disturbance and compaction of the infiltration surface.
- Any required pretreatment facilities should be fully constructed prior to any release of sediment-laden water to the facility. Pretreatment and shallow excavations are intended to prevent the clogging of soil with fines.

### Advantages

- Protect downstream riparian properties from sediment deposits.
- Prevent reduced downstream capacity due to sediment deposition and clogging of downstream facilities..
- Remove particles up to medium silt size 0.02 mm.
- Surface water conveyances can be connected to the facility as site development proceeds.

### Disadvantages

- May become an attractive nuisance. Care must be taken to adhere to all safety practices.
- Failure of a basin, which is not properly located could result in loss of life, damage to homes or buildings or interruption of services such as transportation or power.
- Maintenance and sediment removal is essential for adequate performance.
- Does not reduce turbidity resulting from fine silts and clays in runoff. Basins are more effective when used in conjunction with other measures such as seeding and mulching.

### Design Criteria

- Water temperature in the basin may be too high for direct release. Always moderate the water temperature before it drains into a lake, stream or waterway. Whenever possible, release the trap discharge onsite onto a relatively level, densely grassed area at least 50 feet from a waterway or wetland.
- Require installation of a staff gauge to aid in determining sediment depth.

## CHAPTER 4: EROSION AND SEDIMENT CONTROL MEASURES AND BMPs

---

- The designer may want to route surface water collected from disturbed areas to a sediment basin prior to release from the site.
- A qualified engineer should design temporary sediment basins.

### Inspection & Maintenance

- All damages caused by soil erosion or construction equipment shall be repaired before the end of each working day.
- Remove sediment when the sediment storage zone is half-full. This sediment shall be placed in such a manner that it will not erode from the site. The sediment shall not be deposited downstream from the embankment or in or adjacent to a stream or floodplain.
- When temporary structures have served their intended purpose and the contributing drainage area has been properly stabilized, the embankments and resulting sediment deposit shall be leveled or otherwise disposed of in accordance with the approved erosion and sediment control plan.

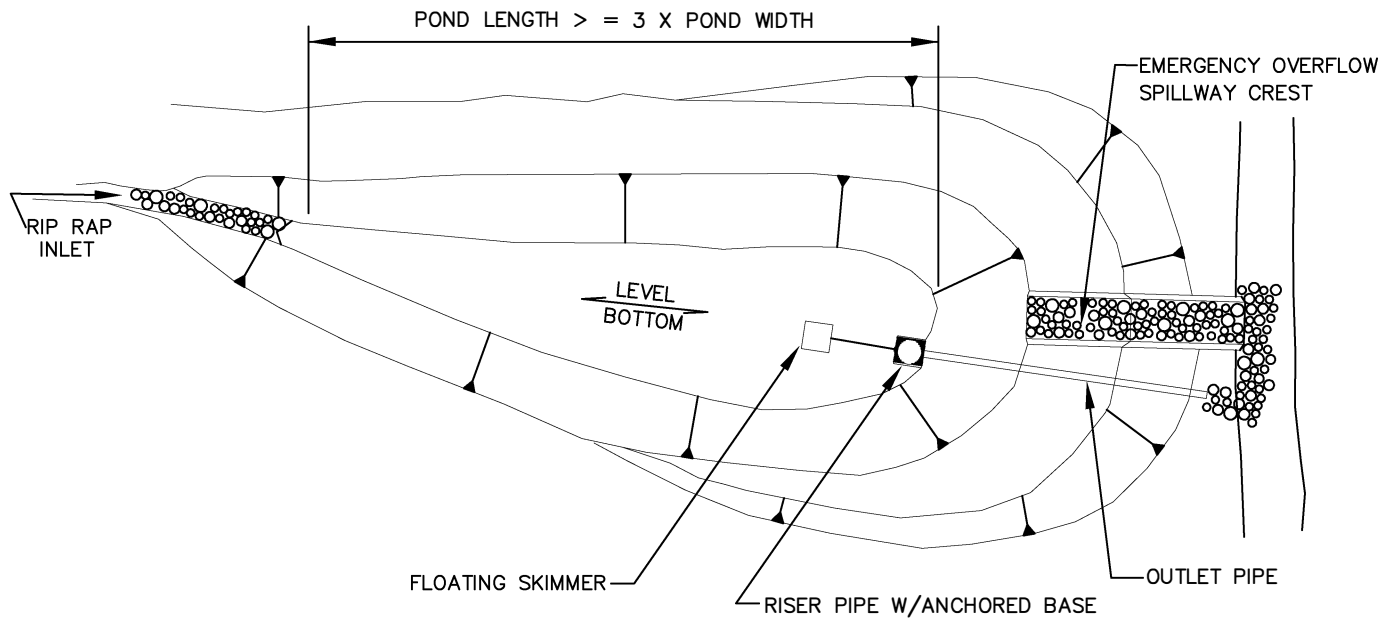

PLAN VIEW

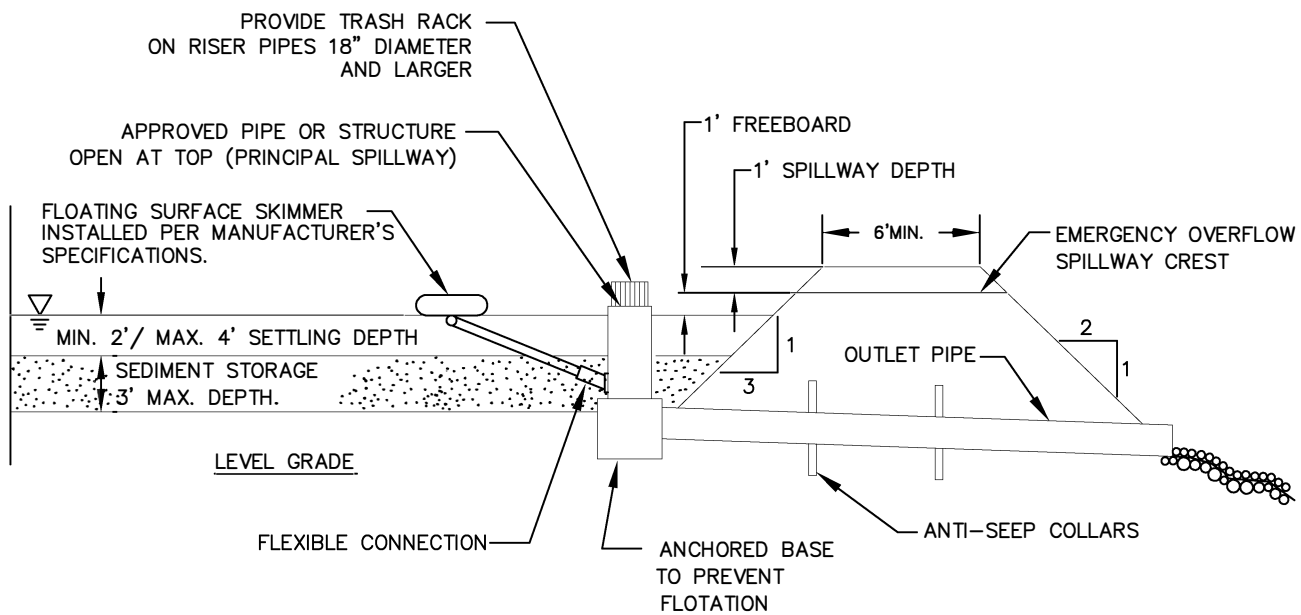

PROFILE

NOTE:

1. 50' MINIMUM OF HIGHLY VEGETATED AREA AND/OR SEDIMENT FENCE IS REQUIRED PRIOR TO DISCHARGING TO STREAM OR WETLAND.

FOR FURTHER INFORMATION ON DESIGN CRITERIA SEE CHAPTER 4 OF EROSION PREVENTION AND SEDIMENT CONTROL PLANNING AND DESIGN MANUAL.

# SEDIMENT BASIN

This page intentionally left blank.

# SEDIMENT FENCE



### 4.3.10 Sediment Fence

Sediment fencing is a temporary sediment trap consisting of an entrenched geotextile stretched across and attached to supporting posts. Sediment fences are adequate to treat flow depths consistent with overland or sheet flow. Standard or heavy-duty sediment fence fabric must meet specific ASTM requirements, outlined in **Table 4-10**.

#### Advantages

- Reduces runoff velocity.
- Requires minimal ground disturbance to install.
- Relatively inexpensive.

#### Disadvantages

- Applicable to small drainage areas and overland flow; not applicable to concentrated flows.
- Incorrect geotextile or installation decreases sediment fence performance.
- Requires frequent maintenance and inspection.

#### Design Criteria

- See **Table 4-11** for Sediment Fence Fabric Specifications
- Install sediment fence along ground contours according to **Table 4-10**
- Sediment fence should only be used for sheet and rill erosion. Not meant to be used in areas of concentrated flows.
- Standard or heavy-duty sediment fence filter fabric shall have manufactured stitched loops with 2"x 2"x4' stake. Stakes shall be installed on/towards the construction side.
- Sediment fences should be installed a minimum of 3 feet from toe of slope in order to maximize storage.
- A trench should be excavated 6 inches deep along the line of the posts.
- Trench should be backfilled and the soil compacted on both sides of the sediment fence.
- Posts should be spaced a maximum of 6 feet apart and driven securely into the ground a minimum of 12 inches.
- When sediment fence approaches its termination point, turn fence uphill and extend one full panel (6 ft).
- When joining two or more sediment fences together, join the two end stakes by wrapping the two ends at least 1½ turns and driving the joined stakes into the ground together.
- Height of a sediment fence should not exceed 3 feet. Storage height and ponding height should never exceed 1.5 feet.

## CHAPTER 4: EROSION AND SEDIMENT CONTROL MEASURES AND BMPs

**Table 4-10 Barrier spacing for general application**

### BARRIER SPACING FOR GENERAL APPLICATION

INSTALL PARALLEL ALONG CONTOURS AS FOLLOWS		
% Slope	Slope	Maximum Spacing on Slope
10 % Flatter	10:1 or Flatter	300 ft
10 > % < 15	10:1 > x < 7.5:1	150 ft
15 > % < 20	7.5:1 > x < 5:1	100 ft
20 > % < 30	5:1 > x < 3.5:1	50 ft
30 > % < 50	3.5:1 > x < 2:1	25 ft

**Table 4-11 Sediment Fence Fabric Specifications**

### WOVEN POLYPROYLENE SEDIMENT FENCE FABRIC

PROPERTY	TEST PROCEDURE	MINIMUM FABRIC VALUE
Grab Tensile Strength	ASTM D-4632	180 lbs.
Grab Elongation	ASTM D-4632	15%
Trapezoid Tear	ASTM D-4533	70 lbs.
Mullen Burst	ASTM D-3786	300 psi
Puncture	ASTM D-4833	80 lbs
Permitivity	ASTM D-4491	.07 sec-1
Permeability	ASTM D-4491	.005 cm/sec
A.O.S.	ASTM D-4751	50 U.S. Sieve
UV Resistance (500 hrs)	ASTM D-4355	90%

## CHAPTER 4: EROSION AND SEDIMENT CONTROL MEASURES AND BMPs

---

### Inspection & Maintenance

- Immediately repair any damage.
- Remove accumulated sediment once it has reached 1/3 the height of the sediment fence or 1 ft maximum.
- Inspect for channel formation parallel to the fence, which indicates the geotextile is acting as a flow barrier.
- Replace deteriorated or clogged geotextile.
- Check for under cutting or piping under fence.



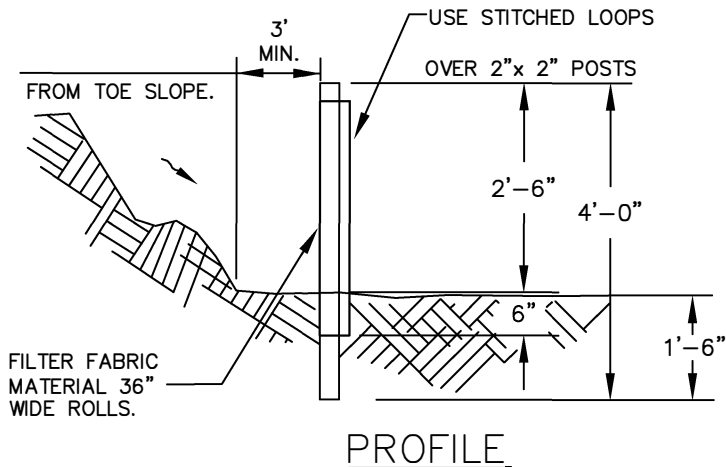
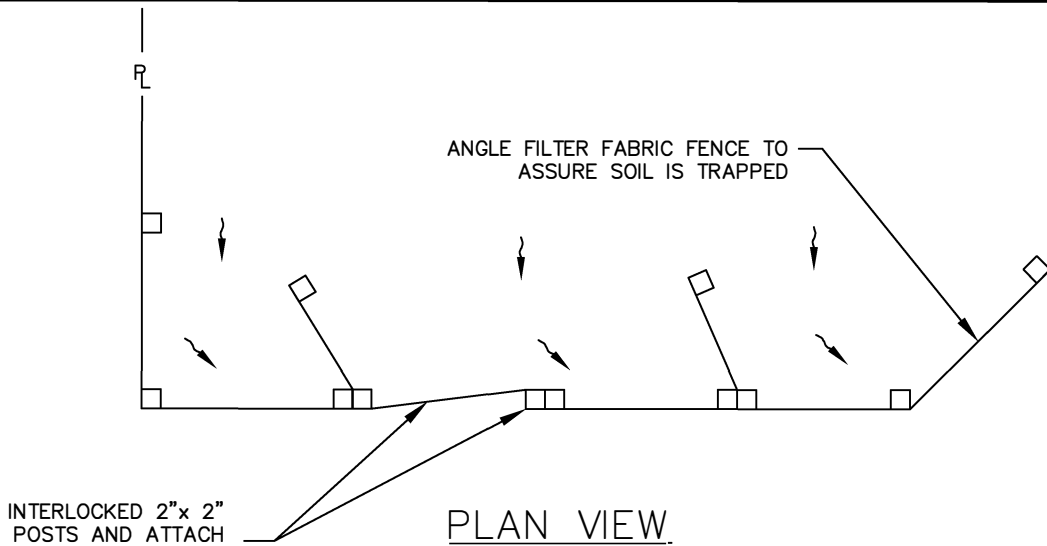

NOTES:

1. SEDIMENT FENCE TO HAVE STITCHED LOOPS AROUND 2" x 2" POSTS.
2. BURY BOTTOM OF FILTER FABRIC 6" VERTICALLY BELOW FINISHED GRADE.
3. 2" x 2" FIR, PINE OR STEEL FENCE POSTS.
4. POSTS TO BE INSTALLED ON UPHILL SIDE OF SLOPE.
5. COMPACT BOTH SIDES OF FILTER FABRIC TRENCH.
6. PANELS MUST BE PLACED ACCORDING TO SPACING ON DRAWING NO. 4-28.

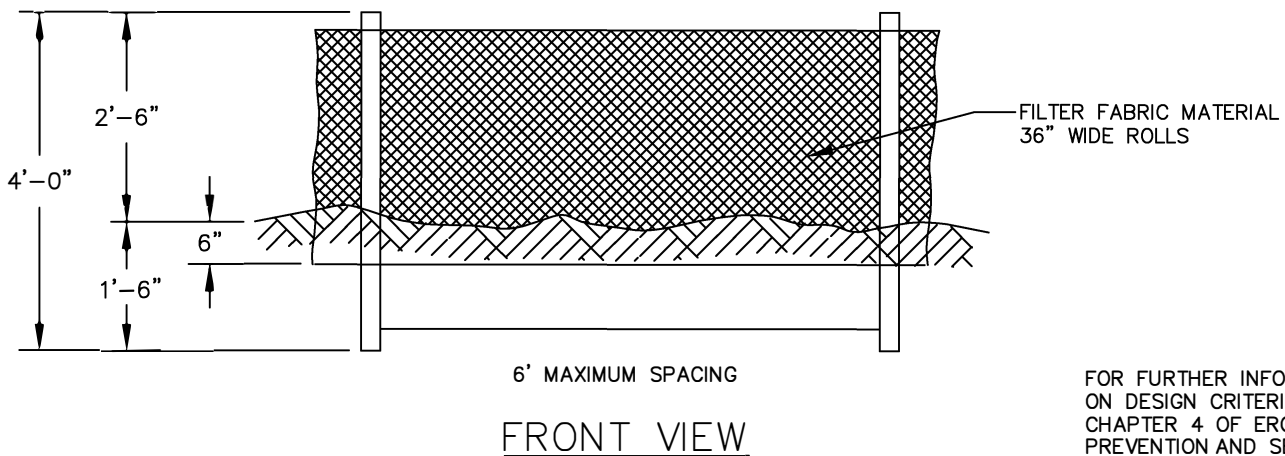

FOR FURTHER INFORMATION ON DESIGN CRITERIA SEE CHAPTER 4 OF EROSION PREVENTION AND SEDIMENT CONTROL PLANNING AND DESIGN MANUAL.

SEDIMENT FENCE

This page intentionally left blank.

# SEDIMENT TRAP



### 4.3.11 Sediment Trap

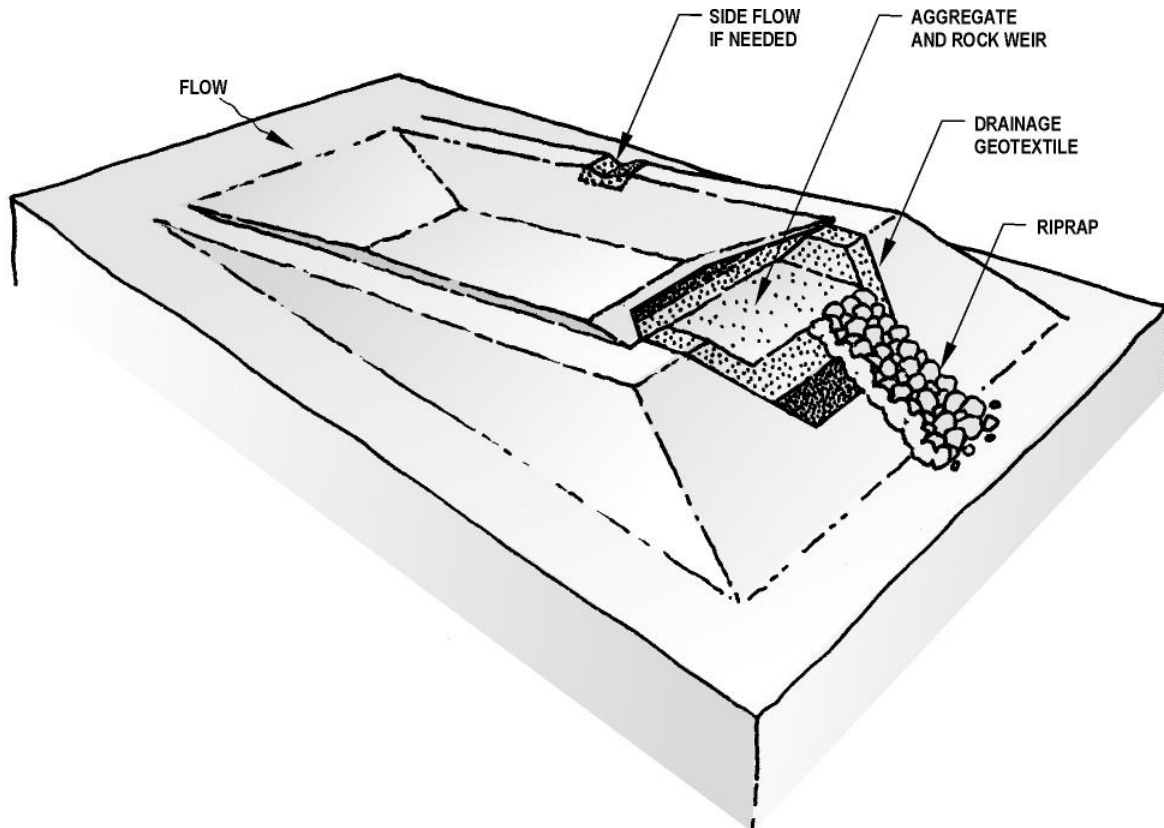

A sediment trap consists of a small, temporary ponding area, with a rock weir or perforated riser pipe at the outlet, formed by excavation or by constructing a weir. The sediment trap serves drainage areas 5 acres and smaller. They are a retention structure designed to remove sediment from runoff by holding a volume of water for a length of time, allowing particles 0.02 mm and larger to settle out. Sediment retention should be used as a last line of defense when included in an ESCP and never used by itself.

#### Combining with Permanent Drainage Facilities

- If a project includes a permanent storm water retention/detention pond, the rough-graded or final-graded facility could function as a trap during construction. Design features of the permanent structure, such as surface area, retention time and outlet control, should meet the design requirements of the temporary facility. Completion of the permanent facility should occur only when all upstream control structures are in place and stabilization of contributing drainage areas is complete.

## CHAPTER 4: EROSION AND SEDIMENT CONTROL MEASURES AND BMPs

---

- If a project includes an infiltration facility, the roughly excavated facility could be used as a trap or basin providing the facility provides the surface area and retention time required by the trap or basin. Excavate the sides and bottom of the facility to a minimum of 3 foot above final grade with a backhoe working at “arms length” to minimize disturbance and compaction of the infiltration surface.
- Additionally, any required pretreatment facilities should be fully constructed prior to any release of sediment-laden water to the facility. Pretreatment and shallow excavations are intended to prevent the clogging of soil with fines.

### Advantages

- Protects downstream riparian properties from sediment deposits.
- Prevents reduced downstream capacity due to sediment deposition and clogging of downstream facilities.
- Can remove particles up to medium silt size (0.02 mm).
- Surface water conveyances can be connected to the facility as site development proceeds. The designer may want to route surface water collected from disturbed areas of the site through a sediment trap prior to release from the site.

### Disadvantages

- May become an attractive nuisance. Care must be taken to adhere to all safety practices.
- Maintenance and sediment removal is essential for adequate performance.
- Intended to serve areas 5 acres and smaller.
- Does not reduce turbidity resulting from fine silts and clays in runoff. Traps are more effective when used in conjunction with other measures such as seeding and mulching.

### Design Criteria

- Construct prior to any upslope clearing and grading.
- Locate in a low area where the trap will intercept all or most of the runoff from the disturbed area before it enters a waterway. Consider having contingency plans in case structure fails.
- Locate the trap so that it is readily accessible for maintenance.
- Provide for diversion dikes and ditches, as needed, to collect and divert water toward the trap.
- Sediment storage volume can be calculated using the RUSLE assuming a minimum one year sediment accumulation period for design purposes. To convert tons of sediment as calculated to cubic feet, multiply 0.05 tons per cubic foot.

## CHAPTER 4: EROSION AND SEDIMENT CONTROL MEASURES AND BMPs

---

- Determine the bottom surface area of the sediment trap using the calculated sediment volume and the maximum 1.5 depth.
- Determine the total trap dimensions by adding an additional 2 feet of depth for settling volume (before overtopping of spillway) above the sediment storage volume, while not exceeding 3:1 side slopes.
- Design the trap with a level bottom, 3:1 or flatter side slopes and a L:W ratio of 3.
- Construct the trap as the first step in the clearing and grading of the site.
- Form the trap by excavation or by construction of compacted embankment. If the trap is formed by embankment, the designer should note that dam safety regulation may apply to heights exceeding 5 foot. The embankment should be stabilized using a cover method such as seeding, mulching or erosion control matting.
- Water temperature in the trap may be too high for direct release. Always moderate the water temperature before it drains into a lake, stream, wetland or waterway.
- Evaluate locations for the release of the trap discharge based upon site specific restrictions. Release the trap discharge onsite onto a relatively level, densely grassed area that is at least 50 feet from a waterway or wetland.

### Inspection & Maintenance

- Constant maintenance is essential for proper functioning.
- Remove sediment from the trap when it reaches one-third the storage capacity.
- Repair any damage to the trap, the embankments or the slopes.

FOR FURTHER INFORMATION  
ON DESIGN CRITERIA SEE  
CHAPTER 4 OF EROSION  
PREVENTION AND SEDIMENT  
CONTROL PLANNING AND  
DESIGN MANUAL.

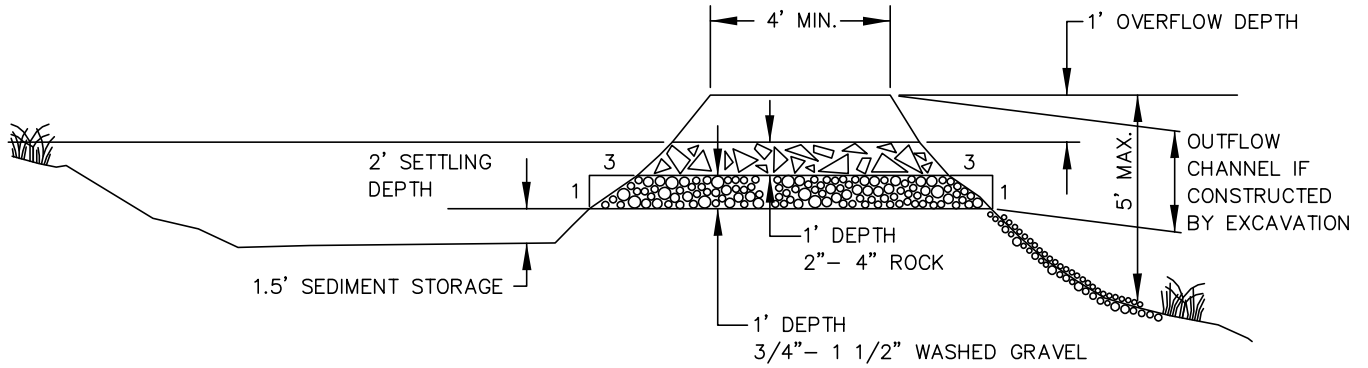

CROSS SECTION

NOTE: MAY BE CONSTRUCTED BY  
EXCAVATION OR BY BUILDING A BERM.

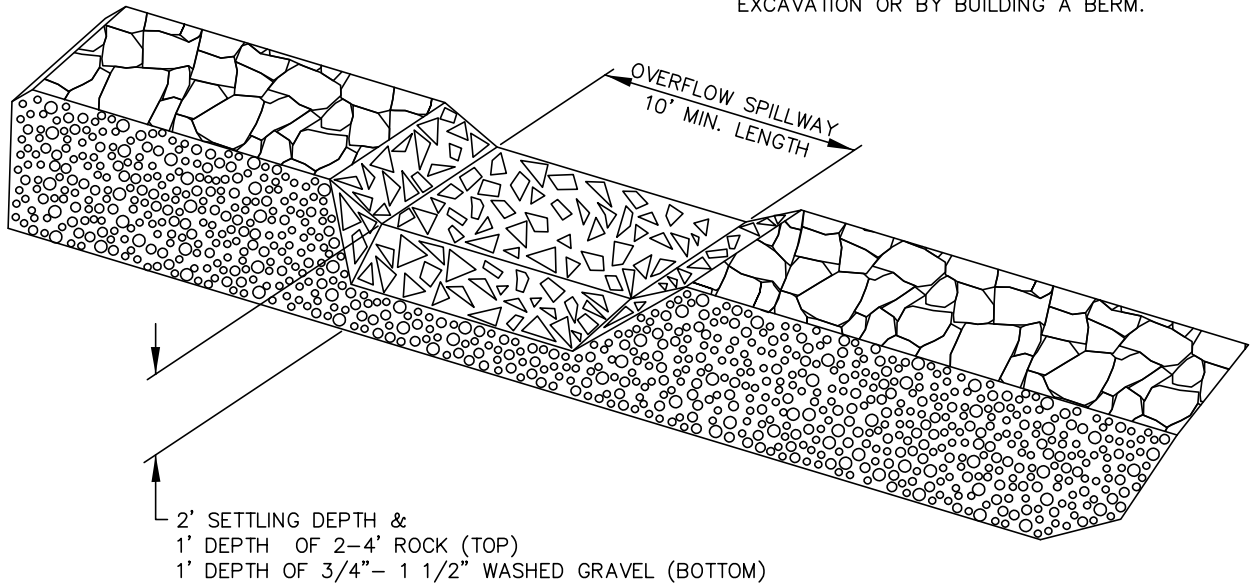

SEDIMENT TRAP OUTLET  
NOT TO SCALE

NOTE:

1. ADDITIONAL BMPS MAY BE REQUIRED TO FILTER RUNOFF FROM THE SEDIMENT TRAP PRIOR TO DISCHARGE FROM THE CONSTRUCTION SITE.

SEDIMENT TRAP

This page intentionally left blank.



# SIDEWALK SUB-GRADE GRAVEL BARRIER



### 4.3.12 Sidewalk Sub-grade Gravel Barrier

A sidewalk sub-grade gravel barrier is an application that provides storage and filtration from run-off on sites with mild slopes. It can be used on all types of projects but is generally used on single-family residential construction sites. Normal installation occurs when excavating for sidewalks at the same time as footing and foundation excavation.

#### Advantages

- Easy to install
- Very economical
- Can retain suspended soils

#### Disadvantages

- May require installation of additional BMPs depending upon soil type and slope
- May need periodic maintenance for removal of suspended materials
- May not be acceptable by local jurisdiction for sub-base material when pouring sidewalk

#### Design Criteria

- Install where the site slopes to a street with curbs and slopes are 5% or less
- Plug all weep holes in curb
- Sidewalk sub-grade must have a minimum 4-inch depth and a 4-foot width.
- A 2 inch layer of approved sub-base material must be installed
- A gravel filter berm may be installed along the inside edge, or toe of slope to increase filtration
- Install sediment barrier on the downhill corner of property to intercept run-off
- On development sites, install sidewalk sub-grade as part of post construction
- On single-family residential construction sites, install at the time of the footing/foundation dig out
- If sidewalk concrete is to be poured prior to establishment of permanent site cover, approved sediment barriers must be installed prior to pouring sidewalk

## CHAPTER 4: EROSION AND SEDIMENT CONTROL MEASURES AND BMPs

---

### Inspection & Maintenance

- Remove and replace gravel when filtering capacity is reduced by half, to maintain performance

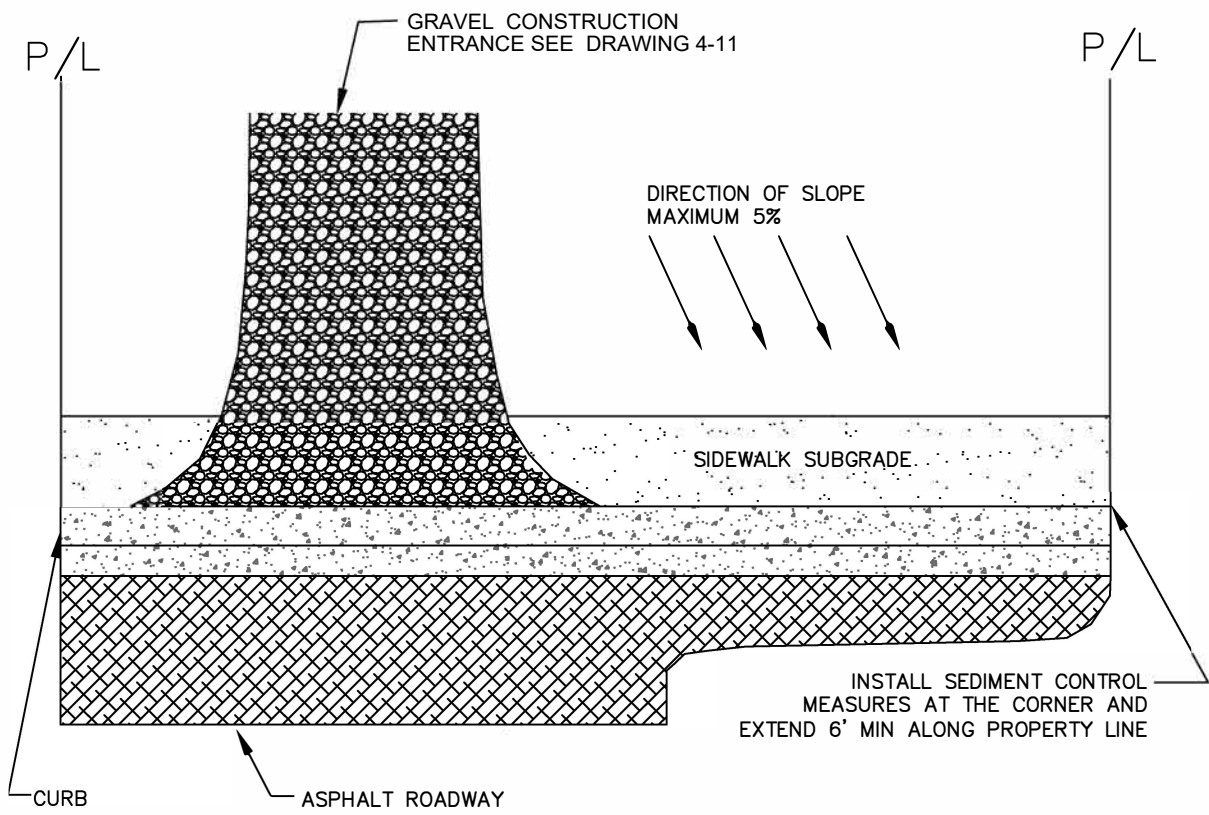

PLAN VIEW

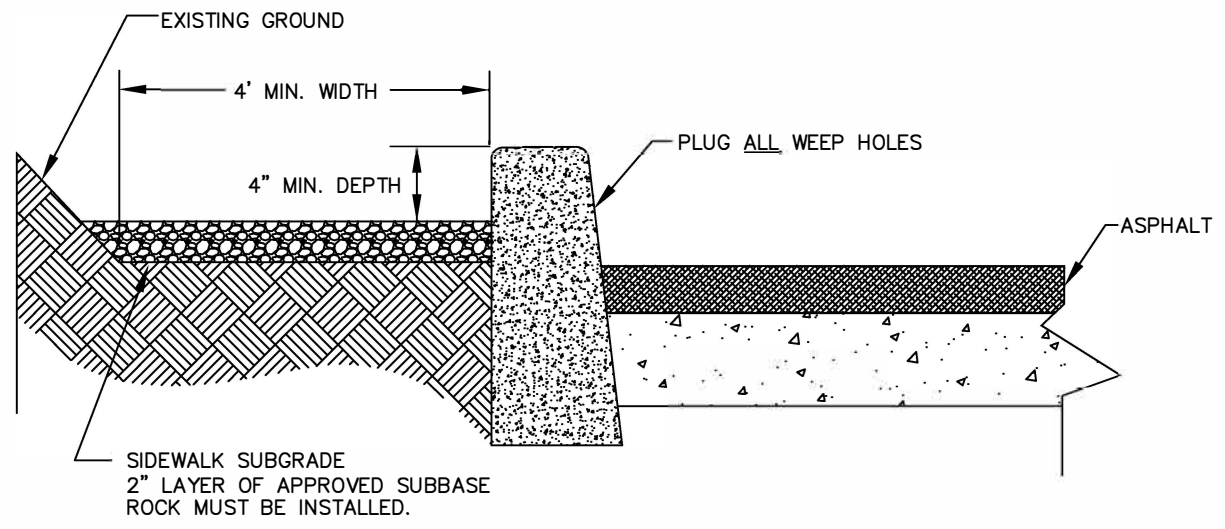

PROFILE

NOTE:

1. SIDEWALK SUBGRADE CAN BE USED FOR ALL CONSTRUCTION ACTIVITIES.

FOR FURTHER INFORMATION ON DESIGN CRITERIA SEE CHAPTER 4 OF EROSION PREVENTION AND SEDIMENT CONTROL PLANNING AND DESIGN MANUAL.

SIDEWALK SUBGRADE

This page intentionally left blank.

# TIRE WASH

**Type 1**



**Type 2**



### 4.2.13 Tire Wash Facility

Two types of tire wash facilities are available depending on the severity of sediment tracking and the size and duration of project. Type 1 can be retro-fitted in the field, using geotextile fabric and rock. Like a stabilized construction entrance, it is graded so that collected wash water is conveyed to a sediment trap, basin or other suitable treatment facility. Type 2 consists of a shallow concrete lined basin partially filled with water, through which exiting vehicles drive.

#### Advantages

- Reduces traffic hazards caused by debris on public roadways.
- Reduces sediment on roadways, which can wash into the storm sewer system.
- Type 1 is easy to construct and is relatively inexpensive.
- Type 2 is useful for high traffic volumes or large projects of long duration.

#### Disadvantages

- Only works if installed at every location where construction traffic leaves the site.
- Fills with sediment quickly and requires frequent maintenance.
- Requires a source of wash water.
- Requires a turnout or doublewide exit to avoid entering vehicles having to drive through wash area.
- Type 2 is costly to construct.
- Both facilities will generate large volumes of sediment-laden water, requiring treatment elsewhere on site.

#### Design Criteria

##### Type 1 (temporary)

- Minimum length: 40 ft.
- Minimum width: 10 ft.
- Minimum rock depth: 8 in.
- Average tire wash sump: 18 in.
- Install subgrade geotextile fabric as a liner
- Use 4-6 in. rock over geotextile fabric
- **Alternate:** 3 in. asphalt lift over a stable base coarse
- Grade the pad to drain to suitable collection and treatment facility.
- Install fencing as necessary to restrict exiting construction vehicle traffic to the tire wash.

## CHAPTER 4: EROSION AND SEDIMENT CONTROL MEASURES AND BMPs

---

### Type 2 (permanent)

- Minimum length: 40 ft. with sloping ingress and egress
- Minimum width: 10 ft.
- Line bottom of basin with geotextile and 12 in. of a coarse rock base
- .
- Average tire wash sump: 18 in.
- Run out impervious area should be a minimum of 50 ft, graded back to facility.
- Construct basin out of 12 in. concrete with steel reinforcement.
- Provide water supply.
- Provide outlet for sediment-laden water discharge to treatment facility or provide pumps and tanks for water treatment.

### Inspection & Maintenance

#### Type 1- Inspect weekly at a minimum, or more depending upon use.

- Clean or replace rock clogged with sediment.
- Re-grade rock as needed.
- Maintain tire wash sump depth.
- Maintain a clean run-out pad.
- Immediately remove any rock that gets carried from the pad to the roadway.
- Ensure that wash water drainage, collection and treatment system is functioning.

#### Type 2 - Inspect weekly at a minimum, or more depending on use.

- Remove/discharge wash water once the condition of the water makes the tire wash no longer effective..
- Remove accumulated sediment from tire wash facility in order to maintain tire wash sump.
- Ensure that wash water collection and treatment system is functioning.



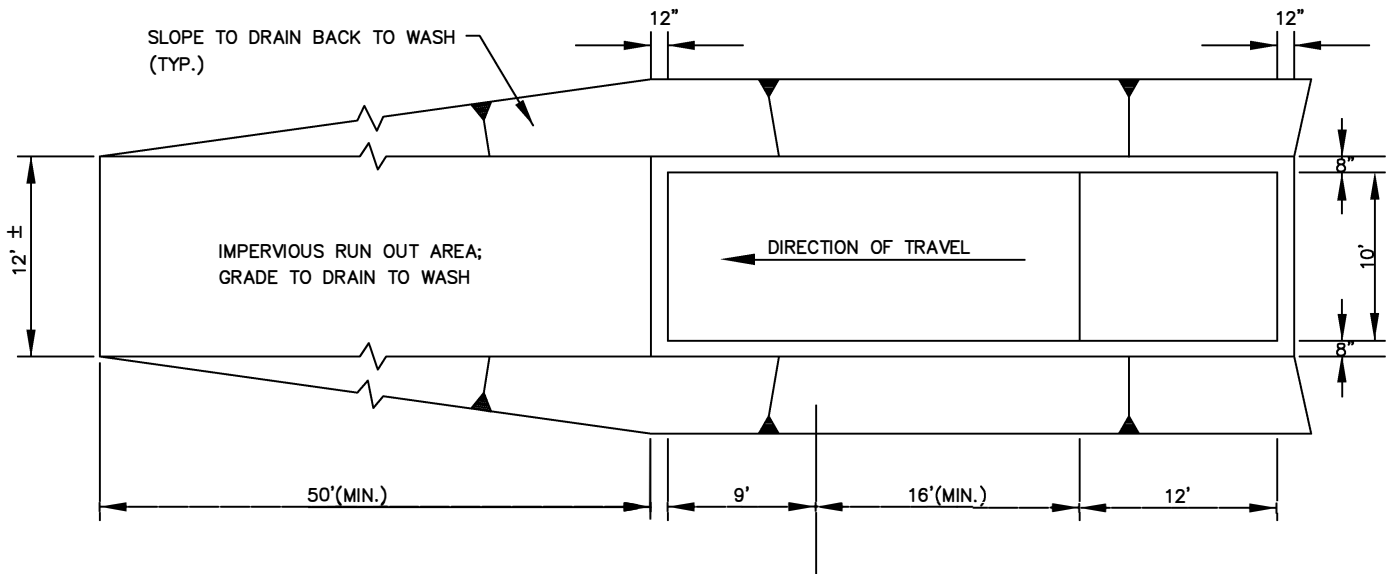

PLAN VIEW

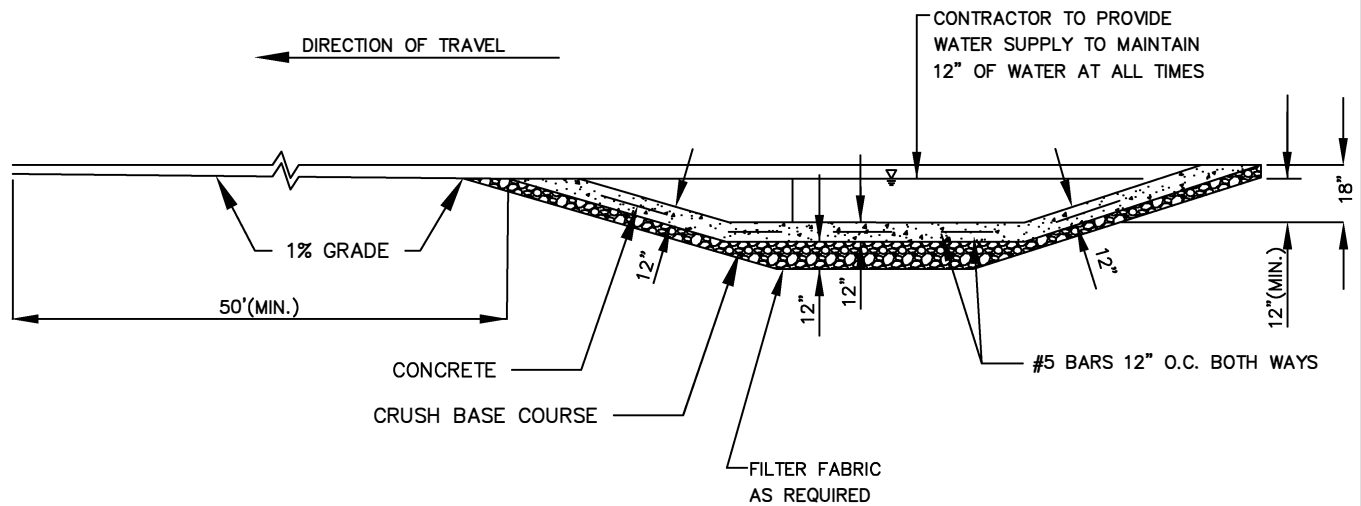

PROFILE

NOTES:

1. CONTRACTOR TO REMOVE ACCUMULATED SEDIMENT AS NEEDED TO PREVENT TRACKING FROM TIRE WASH; SEDIMENT LADEN WATER MAY BE PIPED TO AN APPROVED BMP.
2. USE GEOTEXTILE FABRIC WITH AGGREGATE FOR A TEMPORARY TIRE WASH.

FOR FURTHER INFORMATION ON DESIGN CRITERIA SEE CHAPTER 4 OF EROSION PREVENTION AND SEDIMENT CONTROL PLANNING AND DESIGN MANUAL.

# TIRE WASH—(DRIVE—THROUGH)

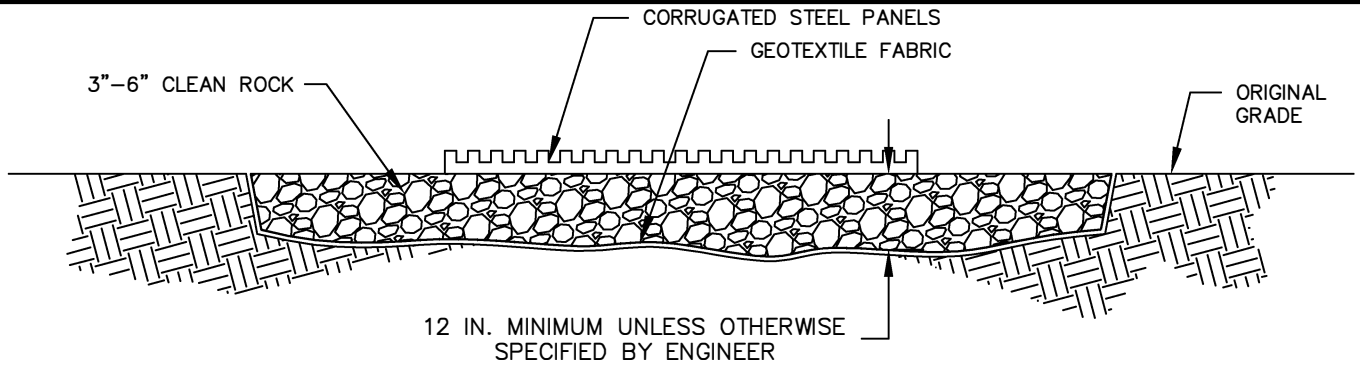

SECTION A-A

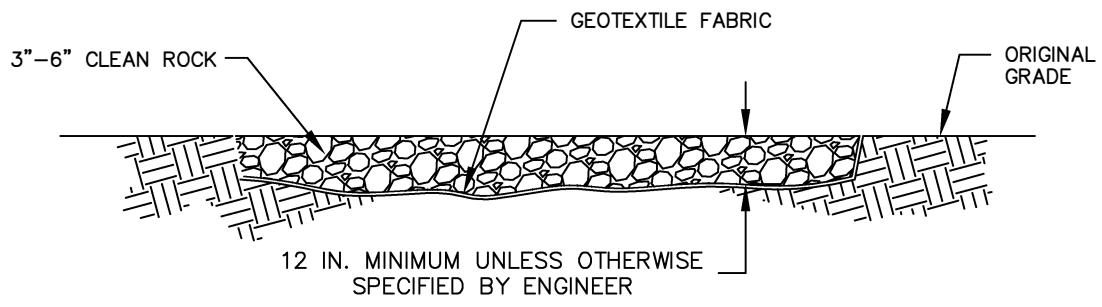

SECTION B-B

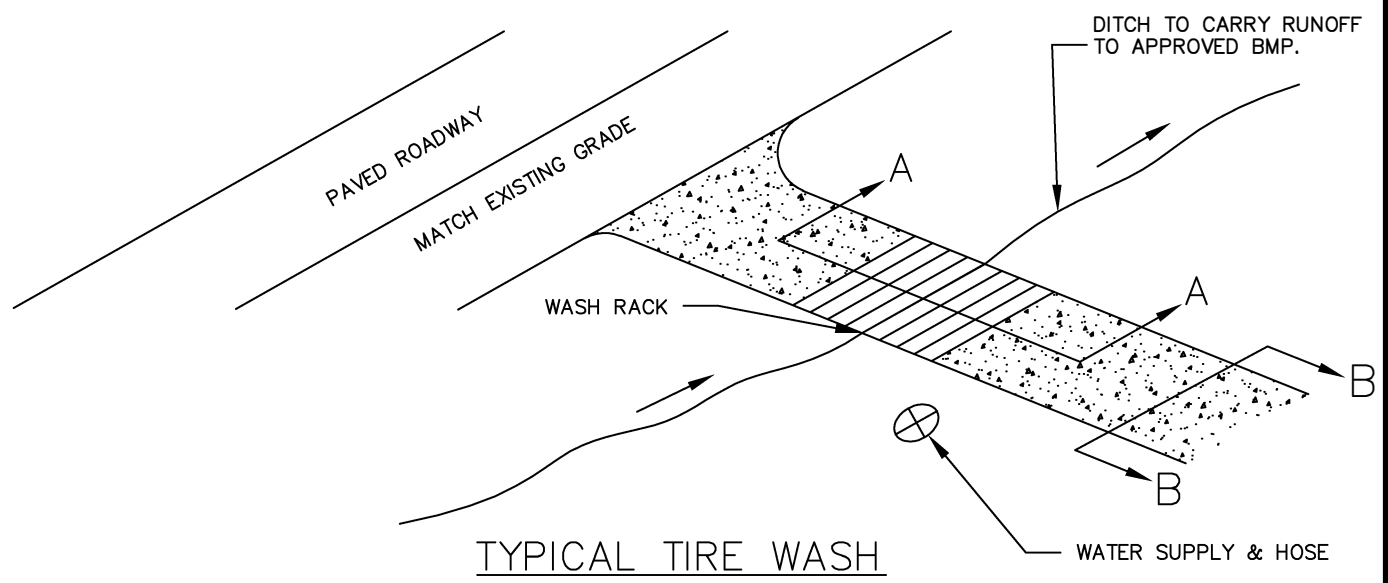

TYPICAL TIRE WASH

NOTE:

1. MANY DESIGNS CAN BE FIELD FABRICATED OR PRE-FABRICATED UNITS MAY BE USED

FOR FURTHER INFORMATION ON DESIGN CRITERIA SEE CHAPTER 4 OF EROSION PREVENTION AND SEDIMENT CONTROL PLANNING AND DESIGN MANUAL.

TIRE WASH  
(MANUAL HOSE WASH)

# WATTLES



### 4.3.14 Wattles

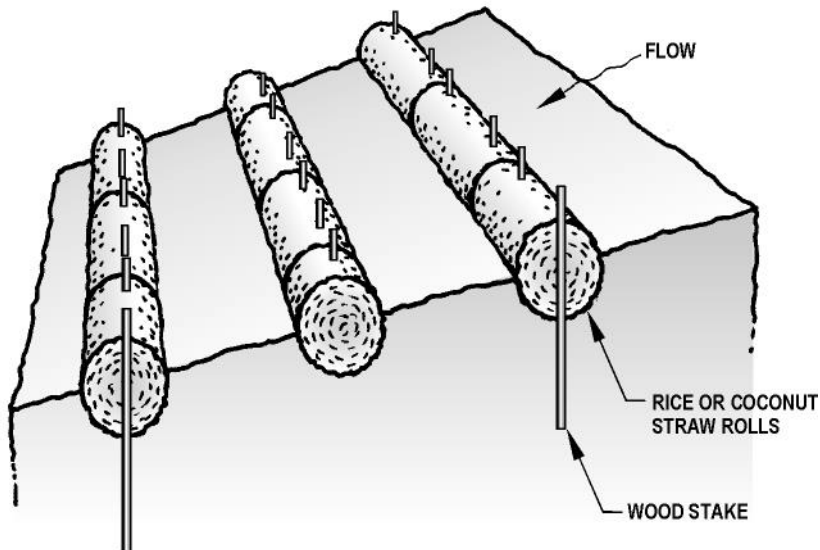

Wattles are manufactured from straw, coconut, or other material that is wrapped in tubular plastic netting. They are approximately 8-9 in. diameter by 7-25 ft. long. Wattles are placed in shallow trenches and staked along the contour of newly constructed or disturbed slopes.

#### Advantages

- They can often replace sediment fences on steep slopes.
- Wattles are short-term solution to help establish native vegetation.
- Wattles store moisture for vegetation planted immediately upslope.
- May be left in place to biodegrade and/or photodegrade.
- Straw becomes incorporated into the soil with time, adding organic material to the soil and retaining moisture for vegetation.
- Reduces runoff velocity.
- Light-weight and easy to install.

#### Disadvantages

- Wattles only function for one or two seasons.
- If not installed properly with sufficient trench, wattles may fail during the first rain event.
- Wattles may require maintenance to ensure that the stakes are holding and the wattles are still in contact with the soil. This is especially true on steep slopes in sandy soil.
- Low sediment retaining capacity may require frequent maintenance.

## CHAPTER 4: EROSION AND SEDIMENT CONTROL MEASURES AND BMPs

### Design Criteria

- Wattles can be made from straw, coconut, or other approved material.
- Slope requires minor preparation prior to installation.
- Rills and shallow gullies should be smoothed as work progresses.
- Wattles should be installed on contours and placed with joints staggered. Trench should be deep enough to accommodate 1/3 to 1/2 the thickness of the wattle.
- Wattles should be installed from the bottom of the slope up.
- Spacing for slope installations should be determined by site conditions. Slope gradient and soil type are the main factors. Refer to table 4-11 for spacing guidelines.
- Wattle must be tight against the soil in trench. Make sure no gaps exist between the soil and the wattle.
- If live willow stakes are installed, use a straight bar to drive holes through wattles.
- Stakes must be driven a minimum of 12 in. into undisturbed material.
- Install stakes every 4 ft. Additional stakes may be driven on the downslope side of the trenches on highly erosive or very steep slopes.
- For flat ground installation along sidewalks or curbs, it may not be necessary to stake the wattles, however trenches must be dug. If sidewalks or curbs have not been backfilled, place wattles against it and backfill behind the wattle.

**Table 4-12 Barrier Spacing For General Applications**

INSTALL PARALLEL ALONG CONTOURS AS FOLLOWS		
% Slope	Slope	Maximum Spacing on Slope
10 % Flatter	10:1 or Flatter	300 ft
10 > % < 15	10:1 > x < 7.5:1	150 ft
15 > % < 20	7.5:1 > x < 5:1	100 ft
20 > % < 30	5:1 > x < 3.5:1	50 ft
30 > % < 50	3.5:1 > x < 2:1	25 ft

### Inspection & Maintenance

- Make sure the wattles are in contact with the soil within the trench and stakes are not broken or dislodged.
- Re-seed, replant vegetation, or install matting if necessary to stabilize slope.

FOR FURTHER INFORMATION  
ON DESIGN CRITERIA SEE  
CHAPTER 4 OF EROSION  
PREVENTION AND SEDIMENT  
CONTROL PLANNING AND  
DESIGN MANUAL.

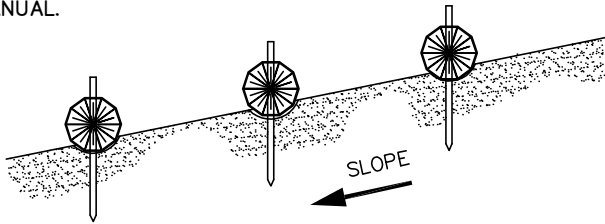

PLACE WATTLES ALONG SLOPE CONTOURS.

PROFILE

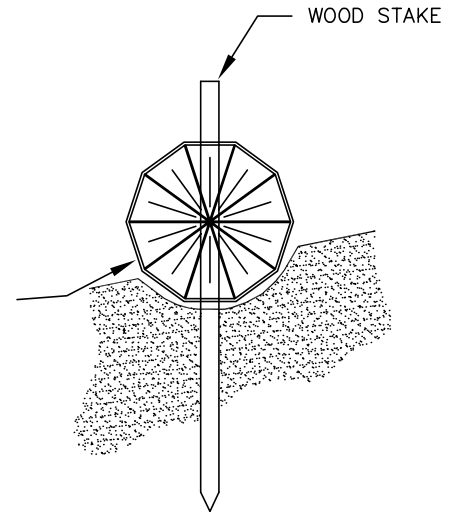

SECTION

WHEAT STRAW, RYE  
GRASS STRAW,  
COCONUT OR  
EXCELSIOR WATTLES

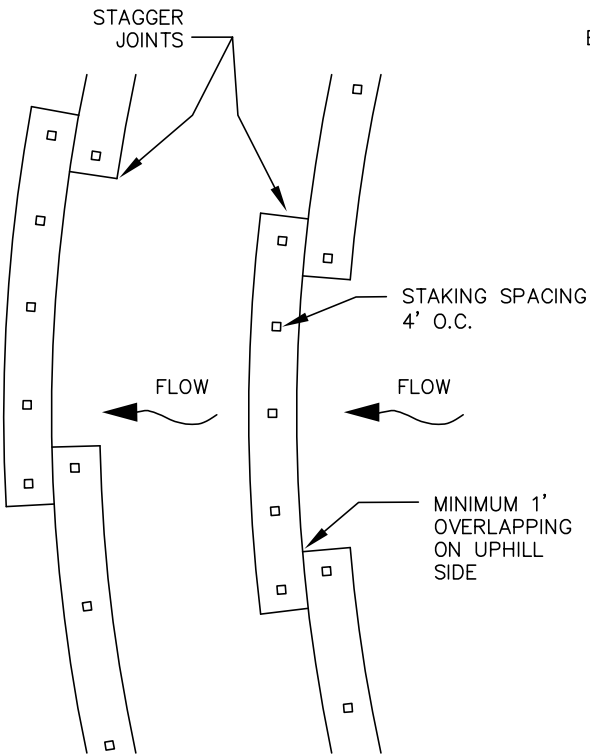

PLAN VIEW

NOTES:

1. STAKING SPECIFICATIONS:
  - a. 1"X2" WOODEN STAKES
  - b. ADDITIONAL STAKES MAY BE INSTALLED ON DOWNHILL SIDE OF WATTLES, ON STEEP SLOPE OR HIGHLY EROSION SOILS.
2. SPACING IN ACCORDANCE WITH DETAIL 4-28
3. REMOVE ALL ROCKS, CLODS, VEGETATION OR OTHER OBSTRUCTIONS SO THAT THE INSTALLED WATTLES WILL HAVE DIRECT CONTACT WITH THE SOIL.
4. INSTALL THE WATTLES IN A 2" DEEP TRENCH, INSURING THAT NO GAPS EXIST BETWEEN THE SOIL AND THE BOTTOM OF THE WATTLE. THE ENDS OF ADJACENT WATTLES SHALL BE OVERLAPPED 1 FT. MINIMUM TO PREVENT SEDIMENT PASSING THROUGH THE FIELD JOINT.

WATTLES

FOR FURTHER INFORMATION  
ON DESIGN CRITERIA SEE  
CHAPTER 4 OF EROSION  
PREVENTION AND SEDIMENT  
CONTROL PLANNING AND  
DESIGN MANUAL.

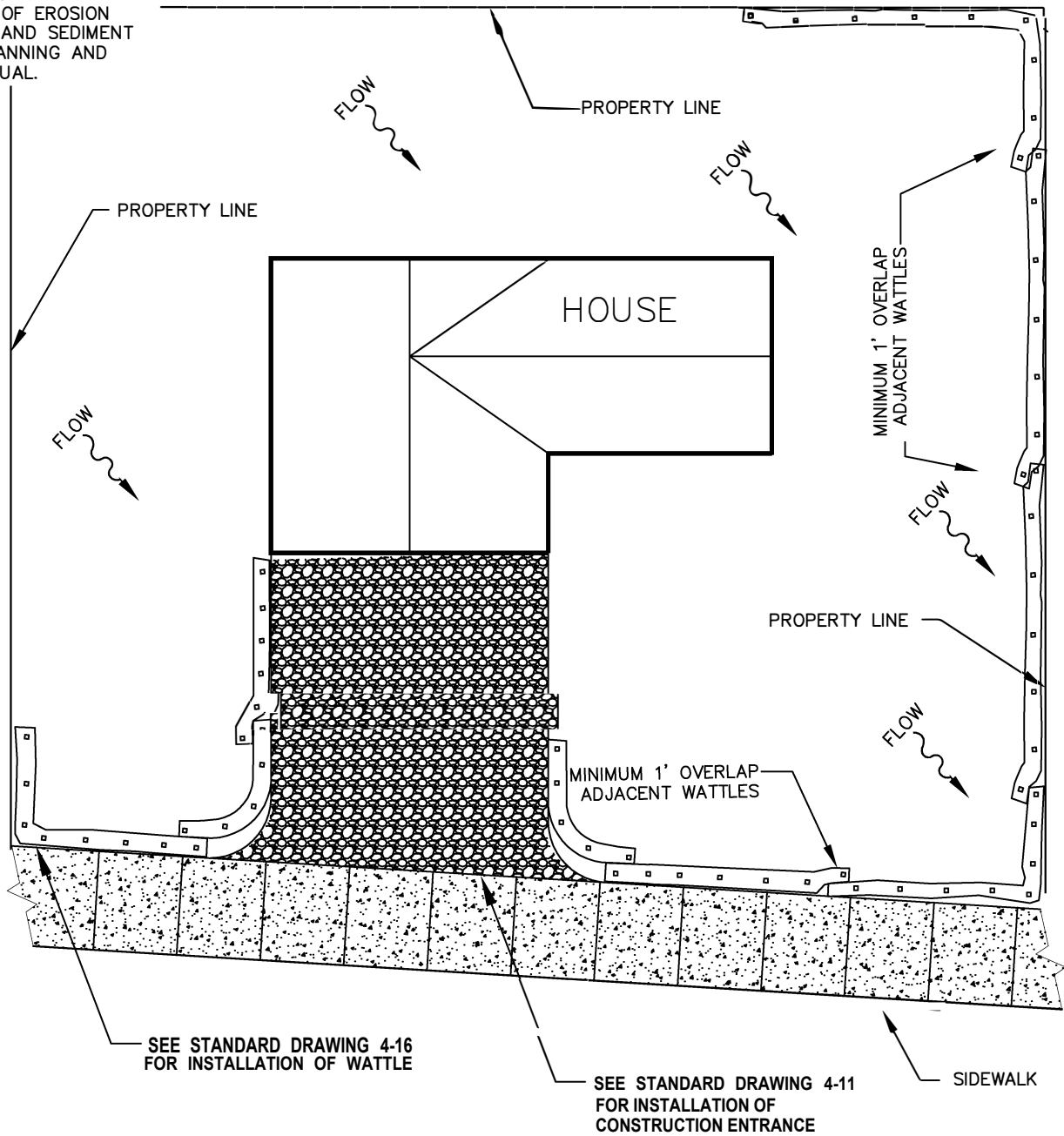

PLAN VIEW

NOTES:

1. SEE STANDARD DRAWING 4-16 FOR INSTALLATION OF WATTLES.
2. ALTERNATE MATERIALS MAY BE USED AS APPROVED BY DISTRICT OR CITY.
3. PERIMETER MEASURES INSTALLED AS NEEDED.

# WATTLES SINGLE FAMILY APPLICATION

## CHAPTER 5

### POLLUTION CONTROL MEASURES AND BMPs

#### 5.1 Management of Other Construction Site Pollutants

There are numerous potential pollutants, other than erosion and sediment, associated with construction activities. Potential pollutants include pollutants associated with the use of concrete and other cement-related mortars and the handling, application, and disposal of construction products and chemicals such as paints, adhesives, and solvents. The improper use and handling of construction materials can result in wash water, spills or wastes being left on the ground. These chemicals can infiltrate into soils causing groundwater contamination or wash-off to surface waters during subsequent storms.

Although this manual is not intended to address all aspects of construction site pollution control, some issues overlap with erosion and sediment control and must be taken into account in the overall planning process. At a minimum the contractor should provide pollution prevention for:

- 1) Off-site tracking of soils;
- 2) Material management;
- 3) Waste management;
- 4) Vehicle and equipment management;
- 5) Site history.

Each construction project is unique, and understanding the pollution risks for each construction activity is essential to successfully selecting and implementing pollution control BMPs. Defining these risks requires careful review of the site characteristics and the nature of the construction project.

Once these pollution risks are defined, BMP objectives can be developed and pollution control BMPs selected. In general the pollution control BMP objectives for construction projects are as follows:

- **Practice Good Housekeeping** – Perform activities in a manner, which keeps potential pollutants from either draining or being transported off-site by managing pollutant sources and modifying construction activities.
- **Contain Waste** – Dispose of all construction waste in designated areas and keep storm water from flowing on or off these areas.

Table 5-1 represents disposal and management options for typical potential pollutants associated with construction activities.



Table 5-1 Quick reference for Pollution Control Measures and BMPs

DISCHARGE/ACTIVITY	BMP DETAIL #	BMP/POLLUTION CONTROL
<b>Painting &amp; Paint Removal</b>		
Excess paint	3, 4, 7	<u>Oil Based</u> – 1. Recycle/reuse. 2. Dispose as hazardous waste. <u>Water Based</u> – 1. Recycle/reuse. 2. Dry residue in cans, dispose as trash. 3. If volume is too much to dry, dispose as hazardous waste.
Paint cleanup	3, 8	Wipe paint out of brushes, then: For <u>oil based</u> paints – 1. Filter & reuse thinners, solvents. 2. Dispose as hazardous waste. For <u>water based</u> paints – 1. Rinse to sanitary sewer.
Paint stripping (with solvent)	3	1. Dispose as hazardous waste.
Non-hazardous paint scraping/sand blasting	3	1. Dry sweep, dispose as trash.
<b>HAZARDOUS</b> paint scraping/sand blasting (e.g. marine paints or paints containing lead or tributyltin)	3, 8	1. Dry sweep, dispose as hazardous waste.

**Table 5-1 (cont.) Quick reference for Pollution Control Measures and BMPs**

<b>DISCHARGE/ACTIVITY</b>	<b>BMP DETAIL #</b>	<b>BMP/POLLUTION CONTROL</b>
<b>General Construction</b>		
Soil from excavations during wet weather periods	9	<ol style="list-style-type: none"> <li>1. Should not be placed in street, on paved areas or near waterways.</li> <li>2. Remove soil from site or backfill by end of day.</li> <li>3. Cover with tarpaulin or surround with sediment barrier, or use other runoff control measures (see chapter 4)</li> <li>4. Place inlet protection at storm drain inlets.</li> <li>5. Clean street, or paved areas to remove dirt that has fallen on roadway surface.</li> </ol>
Soil from excavations placed on paved surfaces during dry season	9	<ol style="list-style-type: none"> <li>1. Keep materials out of storm conveyance systems and off roadways. Remove dirt that has fallen on roadway via sweeping.</li> <li>2. Cover to prevent wind erosion.</li> </ol>
Cleaning streets in construction areas	7	<ol style="list-style-type: none"> <li>1. Dry sweep.</li> <li>2. Use silt ponds, inlet protection and/or similar sediment control techniques when flushing pavement.</li> </ol>
Soil erosion, sediments	(see chapter 4)	<ol style="list-style-type: none"> <li>1. Cover disturbed soils, use erosion controls, block entry to storm drain.</li> <li>2. Seed or plant as soon as possible.</li> </ol>
Fresh cement, grout, mortar	10	<ol style="list-style-type: none"> <li>1. Use/reuse excess.</li> <li>2. Dispose of in trash. Ensure trash container is leak proof.</li> <li>3. Do not allow into surface water and/or collection systems.</li> </ol>
Washwater from concrete/mortar (etc.) cleanup	10	<ol style="list-style-type: none"> <li>1. Direct all wash water into a pit or leak-proof container. The pit does not need to be lined or leak proof, but the pit or container must be designed so that no overflows can occur due to inadequate sizing or precipitation.</li> <li>2. Concrete wash water must not adversely affect groundwater. A wash water container should be lined if soil in the area have high infiltration rates. Check with local jurisdiction.</li> <li>3. Pump and remove to appropriate disposal facility.</li> <li>4. Locate washout area at least 50 feet from storm drains, open ditches, or water bodies</li> </ol>

**Table 5-1 (cont.) Quick reference for Pollution Control Measures and BMPs**

<b>DISCHARGE/ACTIVITY</b>	<b>BMP DETAIL #</b>	<b>BMP/POLLUTION CONTROL</b>
<b>General Construction</b>		
Rinsewater from concrete mixing trucks	10	<ol style="list-style-type: none"> <li>1. Return truck to yard for rinsing into settling pond or lined washout. Wash concrete trucks and equipment off site (in an appropriately protected area) or in a designated concrete washout areas only.</li> <li>2. At construction site, wash into lined settling pond or dirt area and spade in, never allow into storm sewer or waterways.</li> </ol>
Runoff from Foundation Forms & Form Treatment	4, 6	<ol style="list-style-type: none"> <li>1. Store forms on a pervious surface</li> <li>2. Place a tarpaulin over the forms when not in use to prevent contact with precipitation.</li> <li>3. Store form treatment fluids in secondary containment at a designated area.</li> </ol>
Non-hazardous construction and demolition debris	7	<ol style="list-style-type: none"> <li>1. Recycle/reuse (concrete, wood, etc.)</li> <li>2. Dispose as trash.</li> </ol>
Hazardous demolition and construction debris (e.g. asbestos).	8	<ol style="list-style-type: none"> <li>1. Dispose as hazardous waste.</li> </ol>
Concrete saw-cut slurry. (Wet sawing)	10	<ol style="list-style-type: none"> <li>1. Use dry cutting technique and sweep up residue.</li> <li>2. Place a berm on down-slope side of project to collect slurry before it flows off site.</li> <li>3. Vacuum slurry and dispose off-site.</li> <li>4. Shovel out gutters; dispose residue to dirt area, construction yard or landfill.</li> <li>5. Block all storm drains or curb inlets</li> </ol>
Construction dewatering (Nonturbid, uncontaminated groundwater)	1	<ol style="list-style-type: none"> <li>1. Recycle/reuse.</li> <li>2. Discharge to storm drain upon local agency approval.</li> <li>3. Settle, pump water to sanitary sewer or vegetated area at least 50 feet from surface water. Discharge to the sanitary sewer may require a permit from the POTW.</li> </ol>
Construction dewatering (Other than nonturbid, uncontaminated groundwater)	1	<ol style="list-style-type: none"> <li>1. Recycle/reuse.</li> <li>2. Discharge to sanitary sewer, may need permit from the POTW.</li> <li>3. As appropriate, treat prior to discharge to storm drain, requires NPDES permit.</li> </ol>

**CHAPTER 5: POLLUTION CONTROL MEASURES AND BMPs**

**Table 5-1 (cont.) Quick reference for Pollution Control Measures and BMPs**

<b>DISCHARGE/ACTIVITY</b>	<b>BMP DETAIL #</b>	<b>BMP/POLLUTION CONTROL</b>
<b>General Construction</b>		
Leaks from garbage dumpsters	6	<ol style="list-style-type: none"> <li>1. Store dumpster on site and ensure nearby catchbasins are protected.</li> <li>2. Collect, contain leaking material. Eliminate leak, keep covered, return to leasing company for immediate repair.</li> <li>3. If dumpster is used for liquid waste, use plastic liner.</li> </ol>
Leaks from construction debris bins	6, 4	<ol style="list-style-type: none"> <li>1. Insure bins are used for dry nonhazardous materials only. (Suggestion: Fencing, covering help prevent misuse).</li> </ol>
Dumpster cleaning water	6	<ol style="list-style-type: none"> <li>1. Clean at dumpster owner’s facility and discharge waste through grease interceptor to sanitary sewer.</li> <li>2. Clean on site and discharge through grease interceptor to sanitary sewer.</li> </ol>
Cleaning spills from driveways, paved areas	6	<ol style="list-style-type: none"> <li>1. Sweep and dispose as trash (Dry cleaning only).</li> <li>2. For vehicle leaks, follow this 3-step process:               <ol style="list-style-type: none"> <li>a. Clean up leaks with rags or absorbents.</li> <li>b. Sweep, using granular absorbent material (cat litter).</li> <li>c. Mop and dispose of mop water to sanitary sewer.</li> </ol> </li> </ol>
Paving Operations	2	<ol style="list-style-type: none"> <li>1. Avoid paving during wet weather</li> <li>2. Protect drainage systems by diverting runoff or trap/ filter system.</li> <li>3. Place drip pans or absorbent materials under paving equipment when not in use.</li> </ol>
Power washing sidewalks, driveways, plazas	6	Follow this 3-step process: <ol style="list-style-type: none"> <li>a. Collect all water and properly dispose of, do not allow runoff to enter storm sewer.</li> <li>b. Clean oil leaks with rags or absorbents.</li> <li>c. Sweep (Use dry absorbent as needed).</li> </ol>
Aggregate wash from driveway/patio construction	6	<ol style="list-style-type: none"> <li>1. Wash onto dirt area, spade in.</li> <li>2. Pour driveway approach last.</li> <li>3. Collect and remove to appropriate disposal facility.</li> <li>4. Settle, pump water to vegetated area at least 50 feet from surface water.</li> </ol>

**CHAPTER 5: POLLUTION CONTROL MEASURES AND BMPs**

**Table 5-1 (cont.) Quick reference for Pollution Control Measures and BMPs**

<b>DISCHARGE/ACTIVITY</b>	<b>BMP DETAIL #</b>	<b>BMP/POLLUTION CONTROL</b>
<b>Landscape/Garden Maintenance</b>		
Pesticides	5, 8, 14	1. Use all material in container. Rinse containers and then use rinsewater as product. Dispose rinsed empty containers as trash. 2. Dispose unused pesticide as hazardous waste.
Fertilizer Applications	5, 8, 14	1. Sweep any “over spray” material from streets, sidewalks and driveways.
Yard & Garden clippings	7	1. Compost. 2. Take to landfill.
Tree trimming	7	1. Chip if necessary, before composting or recycling.
<b>Vehicle / Equipment Wastes</b>		
Used motor oil & oil filters	14, 6, 4, 8	1. Use secondary containment while storing, send to recycler.
Antifreeze	14, 6, 4, 8	1. Use secondary containment while storing, send to recycler.
Other vehicle fluids and solvents	14, 6, 4, 8	1. Dispose as hazardous waste.
Automobile batteries	14, 4, 8	1. Use secondary containment while storing. 2. Send to auto battery recycler. 3. Take to Recycling Center.
Vehicle Washing	11, 14	1. Wash on pervious surface and use cold water only. 2. Never allow runoff to directly discharge to storm drainage systems.
Mobile Vehicle Washing	11	1. Collect wash water and discharge to sanitary sewer w/ agency approval; never allow wash water to discharge to storm drainage systems.
Rinsewater from dust removal at new car fleets	11	1. If rinsing dust from exterior surfaces for appearance purposes, do not use soap (cold water only).

**Table 5-1 (cont.) Quick reference for Pollution Control Measures and BMPs**

DISCHARGE/ACTIVITY	BMP DETAIL #	BMP/POLLUTION CONTROL
Vehicle leaks & equipment fueling	6, 13, 14	<ol style="list-style-type: none"> <li>1. Clean up leaks with rags or absorbents.</li> <li>2. Sweep, using granular absorbent material (cat litter).</li> <li>3. Fuel only in designated area and place a spill kit in the fueling area.</li> </ol>
<b>Other Wastes</b>		
Roof drains		<ol style="list-style-type: none"> <li>1. If roof is contaminated with industrial waste products, discharge to sanitary sewer with approval from local sanitary authority (may need a discharge permit).</li> <li>2. If no contamination is present, discharge to pervious surface.</li> </ol>
Cooling water Air conditioning condensate		<ol style="list-style-type: none"> <li>1. Recycle/reuse.</li> <li>2. Discharge permit may be required, contact local sanitary authority.</li> </ol>
Pumped groundwater, infiltration/foundation drainage (contaminated)		<ol style="list-style-type: none"> <li>1. Recycle/reuse (landscaping, etc.).</li> <li>2. Discharge permit may be required, contact local sanitary authority</li> </ol>
Fire fighting flows		Under emergency conditions, Fire Department will determine the appropriate procedures to use. If contamination is present, and life and safety are not at issue, Fire Department will attempt to prevent flow to stream or storm drainage system.
Clean-up wastewater from sewer back-up		<ol style="list-style-type: none"> <li>1. Follow this procedure:               <ol style="list-style-type: none"> <li>a. Block storm drain, contain, collect and return spilled material to the sanitary sewer.</li> <li>b. Block storm drain; rinse remaining material to collection point and pump to sanitary sewer. (No rinsewater may flow to storm drain.)</li> <li>c. Report to local jurisdiction</li> </ol> </li> </ol>

## 5.2 Pollution Control Measures and BMPs

This section describes specific BMPs for common construction activities that may pollute storm water. The following fact sheets were adapted from the Construction Methods Handbook developed in 1993 by California's Storm Water Quality Task Force and are suitable for inclusion in many ESCPs or PCPs for typical contractor activities. The BMPs listed are not an exhaustive list, nor will every BMP be appropriate for every situation. Therefore, suggested BMPs that are inappropriate may be deleted and additional BMPs for specific site conditions should be added to the ESCP or PCP. In addition, the selection and implementation of BMPs should be reviewed on a regular basis to match the changing conditions at construction sites.

The following fact sheets have been included.

- BMP 1 Dewatering Operations
- BMP 2 Paving Operations
- BMP 3 Structure Construction and Painting
- BMP 4 Material Delivery and Storage
- BMP 5 Material Use
- BMP 6 Spill Prevention and Control
- BMP 7 Solid Waste Management
- BMP 8 Hazardous Waste Management
- BMP 9 Contaminated Soil Management
- BMP 10 Concrete Waste Management
- BMP 11 Vehicle and Equipment Cleaning
- BMP 12 Vehicle and Equipment Fueling
- BMP 13 Vehicle and Equipment Maintenance
- BMP 14 Employee/Subcontractor Training

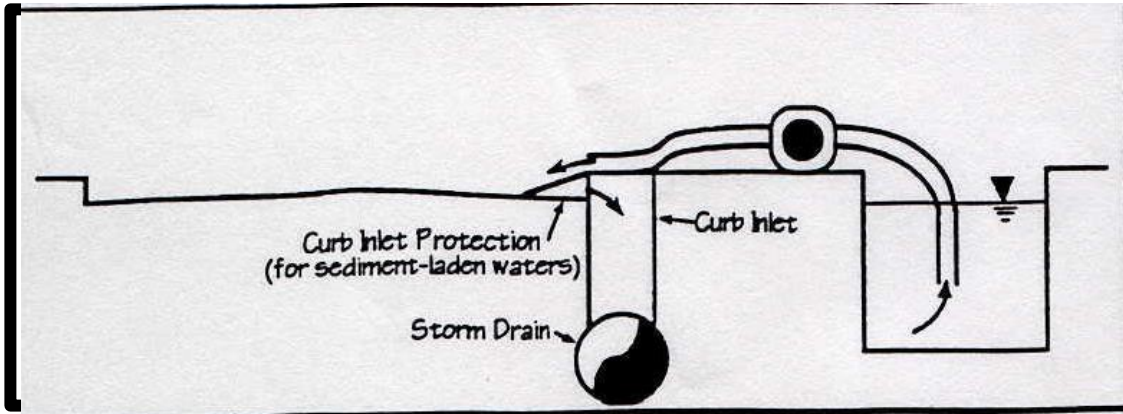

**BMP 1: DEWATERING OPERATIONS**

DESCRIPTION

Prevent or reduce the discharge of pollutants to storm water from dewatering operations by using sediment controls and by testing the groundwater for pollution.

APPROACH

There are two general classes of pollutants that may result from dewatering operations, including sediments, and toxics and petroleum products. High sediment content in dewatering discharges is common because of the nature of the operation. On the other hand, toxics and petroleum products are not commonly found in dewatering discharges unless the site or surrounding area has been used for light or heavy industrial activities, or the area has a history of groundwater contamination. The following steps will help reduce storm water pollution from dewatering discharges:

Sediment

- Use sediment controls to remove sediment from water generated by dewatering. Refer to Chapter 4, page 4-83 for dewatering BMPs.
- Use filtration to remove sediment from a sediment trap or basin. Filtration can be achieved with:
  - Sump pit and a perforated or slit standpipe with holes and wrapped in filter fabric. The standpipe is surrounded by stones, which filter the water as it collects in the pit before being pumped out. Wrapping the standpipe in filter fabric may require an increased suction inlet area to avoid clogging and unacceptable pump operation.
  - Floating suction hose that allows cleaner surface water to be pumped out of trap or basin.

Toxics and Petroleum Products

- In areas suspected of having groundwater pollution, sample the groundwater near the excavation site and have the water tested for known or suspected pollutants at a certified laboratory. Check with the Department of Environmental Quality (DEQ) and the local wastewater treatment plant for their requirements for dewatering, additional water quality tests, and disposal options.
- With a permit, you may be able to recycle/reuse pumped groundwater for landscape irrigation, or discharge to the storm sewer. With a permit from the DEQ or a local agency, you may be able to treat pumped groundwater and discharge it to the municipal wastewater treatment plant via the sanitary sewer.
- For a quick reference on disposal alternatives for specific wastes, see Table 5-1, Quick Reference – Disposal Alternatives.

**TARGET POLLUTANTS**

● Likely to have significant impact		○ Probable Low or Unknown impact	
● Sediment	○ Nutrients	● Toxic Materials	
○ Oil & Grease	○ Floatable Materials	○ Other Construction Waste	



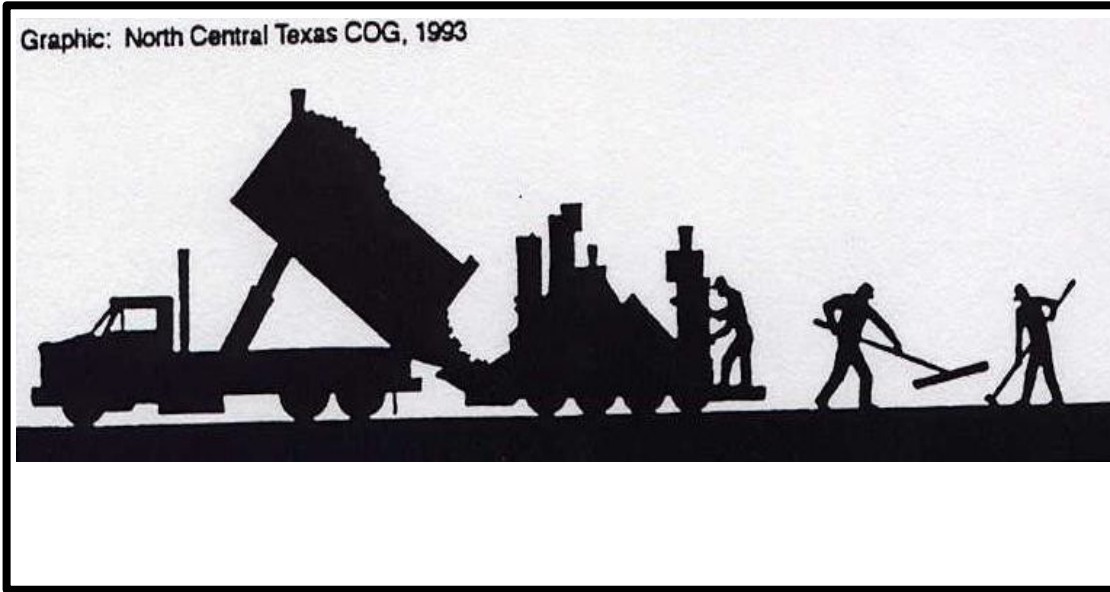

**BMP 2: PAVING OPERATIONS**

**DESCRIPTION**

Prevent or reduce the discharge of pollutants from paving operations, using measures to prevent run-on and runoff pollution, properly disposing of wastes, and training employees and subcontractors.

**APPROACH**

- Avoid paving during wet weather.
- Store materials away from drainage courses to prevent storm water run-on (see BMP 4, Material Delivery and Storage).
- Protect drainage courses, particularly in areas with a grade, by employing BMPs to divert runoff or trap/filter sediment.
- Leaks and spills from paving equipment can contain toxic levels of heavy metals and oil and grease. Place drop pans or absorbent materials under paving equipment when not in use. Clean up spills with absorbent materials rather than burying. See BMP 13 (Vehicle and Equipment Maintenance) and BMP 6 (Spill Prevention and Control) in this chapter.
- Cover catch basins and manhole when applying seal coat, track coat, slurry seal, fog seal, etc.
- Shovel or vacuum saw cut slurry and remove from site. Cover or barricade storm drains during saw cutting to contain slurry.
- If paving involves Portland cement concrete, see BMP 10 (Concrete Waste Management).
- If paving involves asphaltic concrete, the following precautions may help prevent pollutant from entering storm water:
  - Do not allow sand or gravel placed over new asphalt to wash into storm drains, streets, or creeks by sweeping. Properly dispose of this waste by referring to BMP 7 (Solid Waste Management) in this chapter.
  - Old asphalt must be disposed of properly. Collect and remove all broken asphalt from the site and recycle whenever possible.
  - If paving involves on-site mixing plant, follow the storm water permitting requirements for industrial activities.
- Train employees and subcontractors.

**TARGET POLLUTANTS**

● Likely to have significant impact	○ Probable Low or Unknown impact	
● Sediment	○ Nutrients	● Toxic Materials
● Oil & Grease	○ Floatable Materials	○ Other Construction Waste

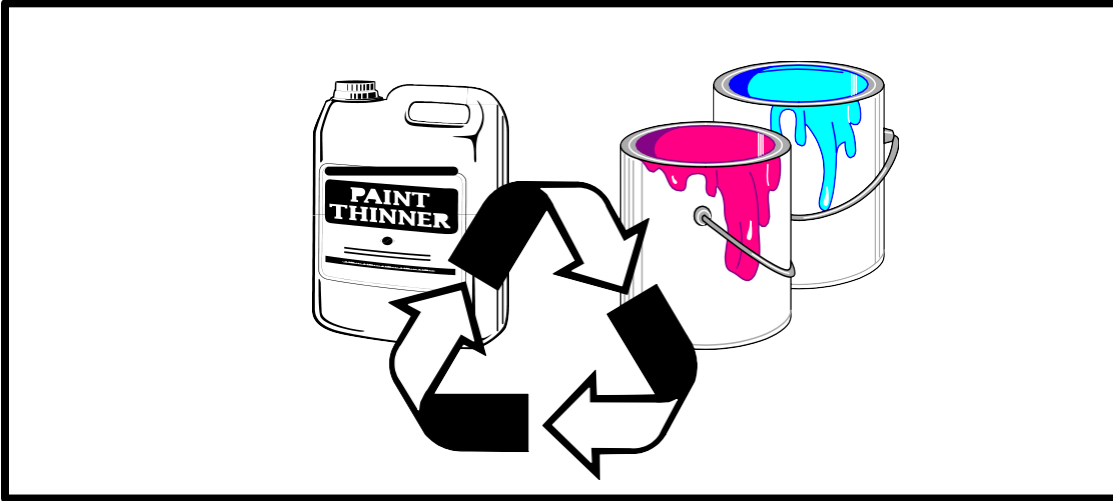

**BMP 3: PAINTING**

**DESCRIPTION**

Prevent or reduce the discharge of pollutants to storm water from painting and associated construction activities by enclosing or covering or berming building material storage areas, using good housekeeping practices, using safer alternative products and training employees and subcontractors.

**APPROACH**

- Keep the work site clean and orderly. Remove debris in a timely fashion. Sweep the area.
- Use soil erosion control techniques if bare ground is exposed.
- Buy recycled or less hazardous products to the maximum extent practicable.
- Conduct painting operations consistent with local air quality and OSHA regulations.
- Properly store paints and solvents. See BMP 4 (Material Delivery and Storage) in this chapter.
- Properly store and dispose waste materials generated from the activity. See the waste management BMPs (BMP 7 to BMP 10) in this chapter.
- Recycle residual paints, solvents, lumber and other materials to the maximum extent practicable.
- Make sure that nearby storm drains are well marked to minimize the chance of inadvertent disposal of residual paints and other liquids.
- Clean the storm drain in the immediate construction area after construction is completed.
- Educate employees who are doing the work.
- Inform subcontractors of company policy on these matters and include appropriate provisions in their contract to make certain proper housekeeping and disposal practices are implemented.
- For a quick reference on disposal alternatives for specific wastes, see Table 5-1.

**TARGET POLLUTANTS**

●	Likely to have significant impact	○	Probable Low or Unknown impact
○	Sediment	○	Nutrients
○	Oil & Grease	●	Toxic Materials
		●	Other Construction Waste

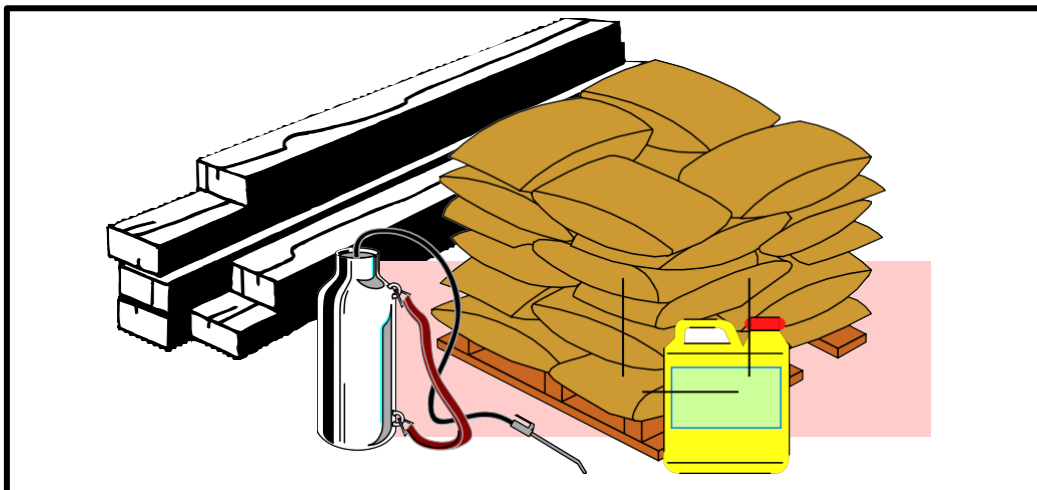

### **BMP 4: MATERIAL DELIVERY AND STORAGE**

#### **DESCRIPTION**

Prevent or reduce the discharge of pollutants to storm water from material delivery and storage by minimizing the storage of hazardous materials on-site, storing materials in a designated area, installing secondary containment, conducting regular inspection, and training employees and subcontractors.

The best management practice covers only material delivery and storage. For other information on materials, see BMP 5 (Material Use), or BMP 6 (Spill Prevention and Control). For information on wastes, see the waste management BMPs in this chapter.

#### **APPROACH**

The following materials are commonly stored on construction sites:

- Soil
- Pesticides and herbicides
- Fertilizers
- Detergents
- Plaster or other products
- Petroleum products such as fuel, oil, and grease, and
- Other hazardous chemicals such as acids, lime, glues, paints, solvents, and curing compounds

Storage of these materials on-site can pose the following risks:

- Storm water pollution
- Injury to workers or visitors
- Groundwater pollution
- Soil contamination









The following steps should be taken to minimize risk of discharge of pollution:

- Designate areas of the construction site for material delivery and storage.
  - Place near the construction entrances, away from waterways
  - Gravel haul roads
  - Avoid transport near drainage paths or waterways
  - Surround with earth berms
  - Place in an area which will be paved
- Storage of reactive, ignitable, or flammable liquids must comply with the fire codes in your area. Contact the local Fire Marshal to review site materials, quantities, and proposed storage area to determine specific requirements.
- For a quick reference on disposal alternatives for specific wastes, see Table 5-1, Quick Reference – Disposal Alternatives.

## CHAPTER 5: POLLUTION CONTROL MEASURES AND BMPs

- Keep an accurate, up-to-date inventory of materials delivered and stored on-site.
- Keep your inventory down.
- Minimize hazardous materials on-site storage.
- Handle hazardous materials as infrequently as possible.
- During the rainy season, consider storing materials in a covered area.
- Store materials in secondary containment such as an earthen dike, horse trough, or even a child's wading pool for non-reactive materials such as containers of detergents, oil, grease, and paints. Small amounts of material may be secondarily contained in "bus boy" trays or concrete mixing trays.
- Do not store chemicals, drums, or bagged materials directly on the ground. Place these items on a pallet and, when possible, in appropriate secondary containment.
- If drums must be kept uncovered, store them at a slight angle to reduce ponding of rainwater on the lids and to reduce corrosion.
- Try to keep chemicals in their original containers, and keep them well labeled.
- Train employees and subcontractors on proper handling and management of waste material.
- Employees trained in emergency spill cleanup procedures should be present when dangerous materials or liquid chemicals are unloaded.
- If significant residual materials remain on the ground after construction is complete, properly remove materials and any contaminated soil (See BMP 9). If the area is to be paved, pave as soon as materials are removed to stabilize the soil.

### TARGET POLLUTANTS

 Likely to have significant impact	 Probable Low or Unknown impact	
 Sediment	 Nutrients	 Toxic Materials
 Oil & Grease	 Floatable Materials	 Other Construction Waste



**BMP 5: MATERIAL USE**

**DESCRIPTION**

Prevent or reduce the discharge of pollutants to storm water by using alternative products, minimizing hazardous material use on-site, and training employees and subcontractors.

**APPROACH**

The following materials are commonly used on construction sites:

- Pesticides and herbicides
- Fertilizers
- Detergents
- Plaster or other products
- Petroleum products such as fuel, oil, and grease, and
- Other hazardous chemicals such as acids, lime, glues, paints, solvents, and curing compounds.

Use of these materials on-site can pose the following risks:

- Storm water pollution
- Injury to workers or visitors
- Groundwater pollution
- Soil contamination

The following steps should be taken to minimize the risk:

- Use less hazardous, alternative materials as much as possible.
- Minimize use of hazardous materials on-site.
- Use materials only where and when needed to complete the construction activity.
- Follow manufacturer’s instructions regarding uses, storage, protective equipment, ventilation, flammability, and mixing of chemicals.
- Personnel who use pesticides should be trained in their use.
- Do not over-apply fertilizers, herbicides, and pesticide. Prepare only the amount needed. Follow the recommended usage instructions. Over-application is expensive and environmentally harmful. Unless on steep slopes, till fertilizers into the soil rather than hydroseeding. Apply surface dressings in several smaller applications, as opposed to one large application, to allow time for infiltration and to avoid excess material being carried off-site by runoff. Do not apply these chemicals just before it rains.
- Train employees and subcontractors in proper material use.

**TARGET POLLUTANTS**

● Likely to have significant impact	○ Probable Low or Unknown impact	
○ Sediment	○ Nutrients	● Toxic Materials
● Oil & Grease	● Floatable Materials	○ Other Construction Waste



### **BMP 6: SPILL PREVENTION AND CONTROL**

#### DESCRIPTION

Prevent or reduce the discharge of pollutants to storm water from leaks and spills by reducing the chance for spills, stopping the source of spills, containing and cleaning up spills, properly disposing of spill materials, and training employees.

The best management practice (BMP) 6 covers only spill prevention and control. BMP 4 (Material Delivery and Storage) and BMP 5 (Material Use), also contain useful information, including on spill prevention. For information on wastes, see the waste management BMPs in this chapter.

#### APPROACH

The following steps will help reduce the storm water impacts of leaks and spills:

##### Define “Significant Spill”

- Different materials pollute in different amounts. Make sure that each employee knows what a “significant spill” is for each material they use, and what is the appropriate response for “significant” and “insignificant” spills.

##### General Measures

- Hazardous materials and wastes should be stored in covered containers and protected from vandalism.
- Place a stockpile of spill cleanup materials where it will be readily accessible.
- Train employees in spill prevention and cleanup.
- Designate responsible individuals.

##### Cleanup

- Clean up leaks and spills immediately.
- On paved surfaces, clean up spills with as little water as possible. Use a rag for small spills, a damp mop for general cleanup, and absorbent material for larger spills. If the spilled material is hazardous, then the used cleanup materials are also hazardous and must be sent to a certified laundry (rags) or disposed of as hazardous waste.
- Never hose down or bury dry material spills. Clean up as much of the material as possible and dispose of properly. See the waste management BMPs in this chapter for specific information.

##### Reporting

- Report significant spills to local agencies, such as the Fire Department. They can assist in clean up.
- Federal regulations require that any significant oil spill into a water body or onto an adjoining shoreline be reported to the National Response Center (NRC) at 800-424-8802 (24 hour).
- Oregon Emergency Response System (OERS) at 1-800-452-0311

Use the following protective measures related to specific activities:

## CHAPTER 5: POLLUTION CONTROL MEASURES AND BMPs









### Vehicle and Equipment Maintenance

- If maintenance must occur on-site, use a designated area and /or a secondary containment, located away from drainage courses, to prevent the run-on of storm water and the runoff of spills.
- Regularly inspect on-site vehicles and equipment for leaks, and repair immediately.
- Check incoming vehicles and equipment (including delivery trucks and employee and subcontractor vehicles) for leaking oil and fluids. Do not allow leaking vehicles or equipment on-site.
- Always use secondary containment, such as a drain pan or drop cloth, to catch spills or leaks when removing or changing fluids.
- Place drip pans or absorbent materials under paving equipment when not in use.
- Use adsorbent materials on small spills rather than hosing down or burying the spill. Remove the adsorbent materials promptly and dispose of properly.
- Promptly transfer used fluids to the proper waste or recycling drums. Do not leave full drip pans or other open containers lying around.
- Oil filters disposed of in trashcans or dumpsters can leak oil and pollute storm water. Place the oil filter in a funnel over a waste oil-recycling drum to drain excess oil before disposal. Oil filters can also be recycled. Ask your oil supplier or recycler about recycling oil filters.
- Store cracked batteries in a non-leaking secondary container. Do this with all cracked batteries, even if you think all the acid has drained out. If you drop a battery, treat it as if it is cracked. Put it into the containment area until you are sure it is not leaking.

### Vehicle and Equipment Fueling

- If fueling must occur on-site, use designated areas, located away from drainage courses, to prevent the run-on of storm water and the runoff of spills.
- Discourage “topping-off” of fuel tanks; an increase in temperature can cause fuel to expand and overflow.
- Always use secondary containment such as a drain pan to catch when fuel spills/leaks.

### *TARGET POLLUTANTS*

 Likely to have significant impact	 Probable Low or Unknown impact	
 Sediment	 Nutrients	 Toxic Materials
 Oil & Grease	 Floatable Materials	 Other Construction Waste

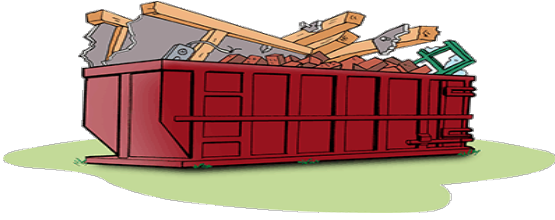

**BMP 7: SOLID WASTE MANAGEMENT**

**DESCRIPTION**

Prevent or reduce the discharge or pollutants to storm water from solid or construction waste by providing designated waste collection areas and containers, arranging for regular disposal, and training employees and subcontractors.

**APPROACH**

Solid waste is one of the major pollutants resulting from construction. Construction debris includes:

- Solid waste generated from trees and shrubs removed during land clearing, demolition or existing structures (rubble), and building construction;
- Packaging materials including wood, paper and plastic;
- Scrap or surplus building materials including scrap metals, rubber, plastic, glass pieces, and masonry products; and
- Domestic wastes including food containers such as beverage cans, coffee cups, paper bags, plastic wrappers, and cigarettes.

The following steps will help keep a clean site and reduce storm water pollution:

- Select designated waste collection areas on-site.
- Inform trash-hauling contractors that you will accept only watertight dumpsters for on-site use. Inspect dumpsters for leaks and repair any dumpster that is not watertight.
- Locate containers in a covered area and/or in a secondary containment.
- Provide an adequate number of containers with lids or covers that can be placed over the container to keep rain out or to prevent loss of wastes. Ensure lids are secure during windy conditions.
- Plan for additional containers and more frequent pickup during the demolition phase of construction.
- Collect site trash daily, especially during raining and windy conditions.
- Erosion and sediment control devices tend to collect litter. Remove this solid waste promptly.
- Make sure that toxic liquid wastes (used oils, solvents, and paints) and chemicals (acids, pesticides, additives, curing compounds) are not disposed of in dumpsters designated for construction debris.
- Salvage or recycle any useful material. For example, trees and shrubs from land clearing can be used as a brush barrier, or converted into wood chips, then used as mulch on graded areas.
- Do not hose out dumpsters on the construction site. Leave dumpster cleaning to trash hauling contractor.
- Arrange for regular waste collection before containers overflow.
- If a container does spill, clean up immediately.
- Make sure that construction waste is collected, removed, and disposed of only at authorized disposal areas.
- Cover loads of material that are hauled off site.
- Train employees and subcontractors in proper solid waste management.
- For a quick reference on disposal alternatives for specific wastes, see Table 5-1.

**TARGET POLLUTANTS**

●	Likely to have significant impact	○	Probable Low or Unknown impact
●	Sediment	○	Nutrients
○	Oil & Grease	○	Toxic Materials
●	Floatable Materials	●	Other Construction Waste



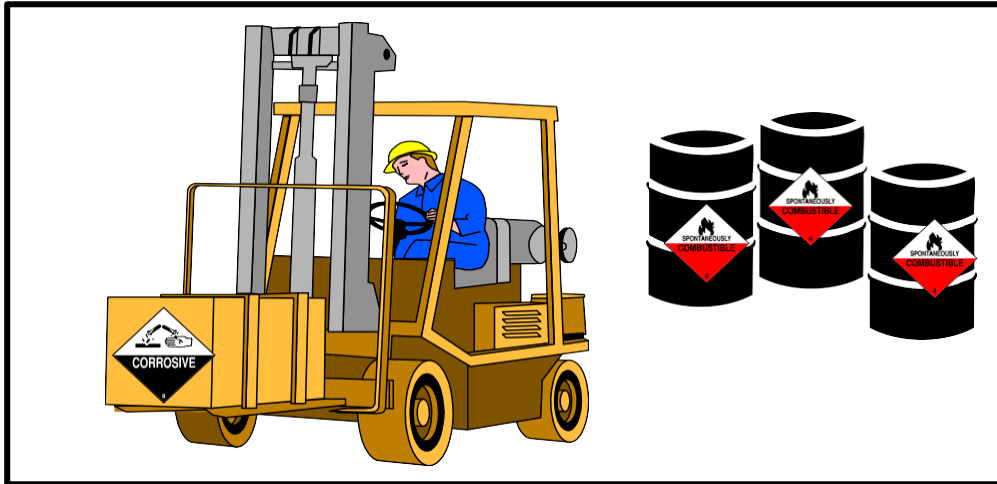

## **BMP 8: HAZARDOUS WASTE MANAGEMENT**

### DESCRIPTION

Prevent or reduce the discharge of pollutants to storm water from hazardous waste through proper material use, waste disposal, storage and training of employees and subcontractors.

### APPROACH

Many of the chemicals used on-site can be hazardous materials that become hazardous waste upon disposal. These wastes may include:

- Paints and solvents
- Petroleum products such as oils, fuels, and grease
- Herbicides and pesticides
- Acids for cleaning masonry
- Concrete curing compounds

In addition, sites with existing structures may contain wastes that must be disposed of in accordance with Federal, State, and local regulation. These wastes include:

- Sandblasting grit mixed with lead-, cadmium-, or chromium-based paints;
- Asbestos; and
- PCB's (particularly in older transformers).

The following steps will help reduce storm water pollution from hazardous wastes:

#### Material Use

- Use the entire product before disposing of the container.
- Do not remove the original product label as it contains important safety and disposal information.
- Do not over-apply herbicides and pesticides. Prepare only the amount needed. Follow the recommended usage instruction. Over-application is expensive and environmentally harmful. Apply surface dressings in several smaller applications, as opposed to one large application, to allow time for infiltration and to avoid excess material being carried off-site by runoff. Do not apply these chemicals just before it rains. People applying pesticides must be certified in accordance with Federal and State regulation.
- Do not clean out brushes or rinse paint containers into the dirt, street, gutter, storm drain, or stream. "Paint out" brushes as much as possible. Rinse water-based paints to the sanitary sewer. Filter and re-use thinners and solvents. Dispose of excess oil-based paint and sludge as hazardous waste.

#### Waste Recycling/Disposal

- Select designated hazardous waste collection areas on-site.









## CHAPTER 5: POLLUTION CONTROL MEASURES AND BMPs

- Hazardous materials and wastes should be stored in covered containers and protected from vandalism.
- Place hazardous waste containers in secondary containment.
- Do not mix wastes. This can cause chemical reactions, make recycling impossible, and complicate disposal.
- Recycle material such as used oil or water-based paint.
- Make sure that toxic liquid wastes (used oils, solvents, and paints) and chemicals (acids, pesticides, additives, curing compounds) are not disposed of in dumpsters designated for construction debris.
- Arrange for regular waste collection before containers overflow.
- Make sure that hazardous waste (e.g. excess oil-based paint and sludge) is collected, removed, and disposed of only at an authorized disposal area.
- For a quick reference on disposal alternatives for specific wastes, see Table 5-1.

### Training

- Train employees and subcontractors in proper hazardous waste management.
- Warning signs should be placed in areas recently treated with chemicals.
- Place a stockpile of spill cleanup materials where it will be readily accessible.
- If a container does spill, clean up immediately.

### *TARGET POLLUTANTS*

 Likely to have significant impact	 Probable Low or Unknown impact	
 Sediment	 Nutrients	 Toxic Materials
 Oil & Grease	 Floatable Materials	 Other Construction Waste

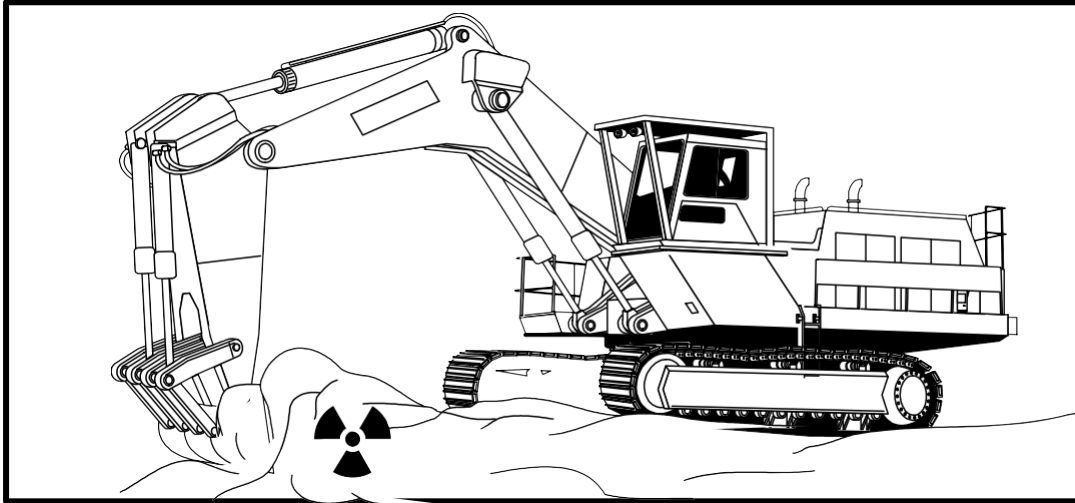

**BMP 9: CONTAMINATED SOIL MANAGEMENT**

**DESCRIPTION**

Prevent or reduce the discharge of pollutants to storm water from contaminated soil and highly acidic or alkaline soils by conducting pre-construction surveys, inspecting excavations regularly, and remediating contaminated soil promptly.

**APPROACH**

Contaminated soils may occur on your site for several reasons including:

- Past site uses and activities;
- Detected or undetected spills and leaks; and
- Acid alkaline solutions from exposed soil or rock formations high in acid or alkaline forming elements.

Most developers conduct pre-construction environmental assessments as a matter of routine. Recent court rulings holding contractors liable for cleanup costs when they unknowingly move contaminated soil highlight the need for contractors to confirm that a site assessment is complete before earth moving begins.

The following steps will help reduce storm water pollution for contaminated soil:

- Conduct thorough site planning including pre-construction research and geologic surveys.
- Look for contaminated soil as evidenced by discoloration, odors, differences in soil properties, abandoned underground tanks or pipes, or buried debris.
- Prevent leaks and spills to the maximum extent practicable. Contaminated soil can be expensive to treat and/or dispose of properly. However, addressing the problem before construction is much less expensive than after the structures are in place.
- Test suspected soils at a certified laboratory.
- If the soil is contaminated, work with the local regulatory agencies to develop options for treatment and/or disposal.
- For a quick reference on disposal alternatives for specific wastes, see Table 5-1.

**TARGET POLLUTANTS**

●	Likely to have significant impact	○	Probable Low or Unknown impact
●	Sediment	○	Nutrients
○	Oil & Grease	○	Floatable Materials
●	Toxic Materials	○	Other Construction Waste

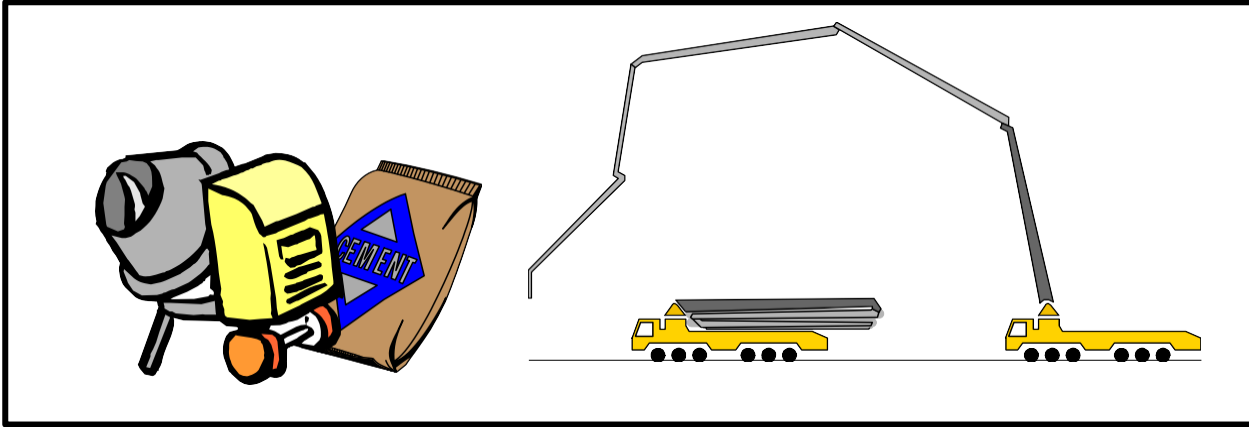

**BMP 10: CONCRETE WASTE MANAGEMENT**

DESCRIPTION

Prevent or reduce the discharge of pollutants to storm water from concrete waste by conducting washout off-site, performing on-site washout in a designated area, and training employees and subcontractors.

APPROACH

The following steps will help reduce storm water pollution from concrete wastes:

- Store dry and wet materials under cover, away from drainage areas.
- Avoid mixing excess amount of fresh concrete or cement on-site.
- Perform washout of concrete trucks off-site or in designated areas only.
- Do not wash out concrete trucks into storm drains, open ditches, streets, or streams.
- Do not allow excess concrete to be dumped on-site, except in designated areas.
- For on-site washout:
  - Locate washout area at least 50 feet from storm drains, open ditches, or water bodies. Do not allow runoff from this area by constructing a temporary pit or bermed area large enough for the amount of liquid and solid waste that will be generated;
  - Wash out wastes into the temporary pit where the concrete can be set, be broken up, and then disposed of properly.
- When washing concrete to remove fine particles and expose the aggregate, avoid creating runoff by draining the water to a bermed or level area.
- Do not wash sweepings from exposed aggregate concrete into the street or storm drain. Collect and return sweepings to aggregate base stockpile, or dispose in the trash.
- Train employees and subcontractors in proper concrete waste management.
- For a quick reference on disposal alternatives for specific wastes, see Table 5-1.

TARGET POLLUTANTS

●	Likely to have significant impact	○	Probable Low or Unknown impact
●	Sediment	○	Nutrients
○	Oil & Grease	○	Floatable Materials
		●	Other Construction Waste
			Toxic Materials

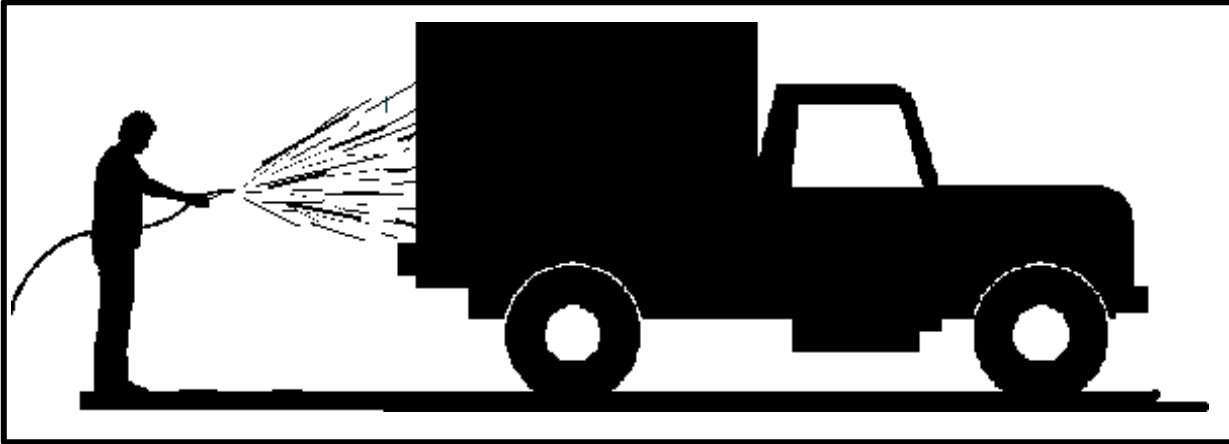

**BMP 11: VEHICLE AND EQUIPMENT CLEANING**

**DESCRIPTION**

Prevent or reduce the discharge of pollutants to storm water from vehicles and equipment by using off-site facilities, washing in designated contained areas only, eliminating discharges to the storm drain by infiltrating or recycling the wash water, and training employees and subcontractors.

**APPROACH**

- Use off-site commercial washing business as much as possible. Washing vehicles and equipment outdoors or in areas where wash water flows onto paved surfaces or into drainage pathways can discharge pollutants. If you wash a large number of vehicles or pieces of equipment, consider conducting this work at an off-site commercial business. These businesses are better equipped to handle and dispose of the wash waters properly. Performing this work off-site can also be economical by eliminating the need for a separate washing operation at your site.
- If washing must occur on-site, use designated bermed wash areas to prevent wash water contact with storm water, creeks, rivers, and other water bodies. The wash area can be sloped for wash water collection and subsequent infiltration into the ground.
- Use as little water as possible to avoid having to install erosion and sediment control for the wash area.
- Use phosphate-free, biodegradable soaps.
- Educate employees and subcontractors on pollution prevention measures.
- Do not permit steam cleaning on-site. Steam cleaning can generate significant pollutant concentrations.
- For a quick reference on disposal alternatives for specific wastes, see Table 5-1.

**TARGET POLLUTANTS**

● Likely to have significant impact		○ Probable Low or Unknown impact	
● Sediment	○ Nutrients	● Toxic Materials	
● Oil & Grease	○ Floatable Materials	○ Other Construction Waste	

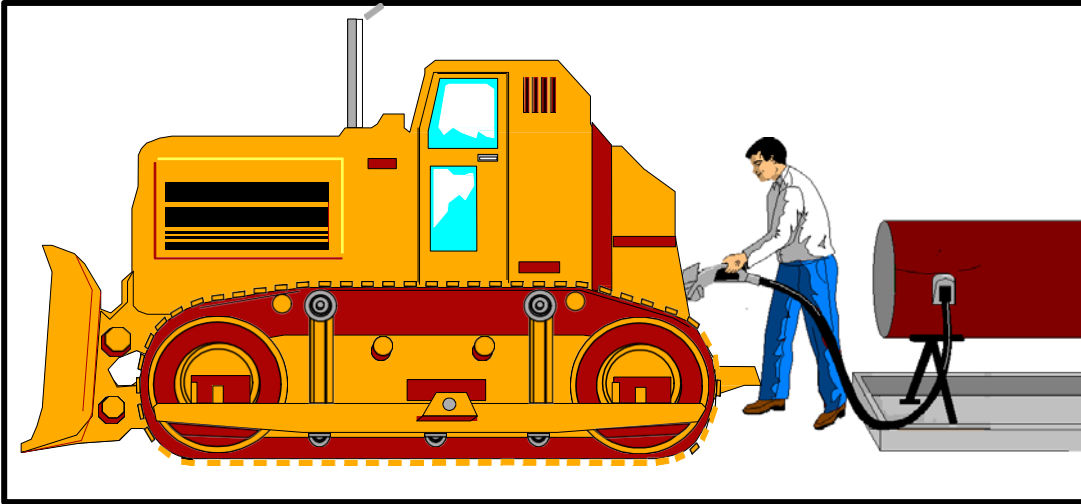

**BMP 12: VEHICLE AND EQUIPMENT FUELING**

DESCRIPTION

Prevent fuel spills and leaks, and reduce their impacts to storm water by using off-site facilities, fueling in designated areas only, enclosing or covering stored fuel, implementing spill controls, and training employees and subcontractors.

APPROACH

- Use off-site fueling stations as much as possible. Fueling vehicles and equipment outdoors or in areas where fuel may spill/leak onto paved surfaces or into drainage path ways can discharge pollutants. If you fuel a large number of vehicles or pieces of equipment, consider using an off-site fueling station. These businesses are better equipped to handle fuel and spills properly. Performing this work off-site can also be economical by eliminating the need for a separate fueling area at your site.
- If fueling must occur on-site, use designated areas, located away from drainage ways.
- Discourage “topping-off” of fuel tanks.
- Always use secondary containment, such as a drain pan or drop cloth, when fueling to catch spills/leaks.
- Place a stockpile of spill cleanup materials where it will be readily accessible.
- Use adsorbent on small spills rather than hosing down or burying the spill. Remove the adsorbent materials promptly and dispose of properly.
- Carry out all Federal and State requirements regarding stationary above ground storage tanks.
- Avoid mobile fueling of mobile construction equipment around the site; rather, transport the equipment to designated fueling areas. With the exception of tracked equipment such as bulldozers and perhaps forklifts, most vehicles should be able to travel to a designated area with little lost time.
- Train employees and subcontractors in proper fueling and cleanup procedures.

TARGET POLLUTANTS

● Likely to have significant impact		○ Probable Low or Unknown impact	
○ Sediment	○ Nutrients	● Toxic Materials	
● Oil & Grease	○ Floatable Materials	○ Other Construction Waste	



**BMP 13: VEHICLE AND EQUIPMENT MAINTENANCE**

DESCRIPTION

Prevent or reduce the discharge of pollutants to storm water from vehicle and equipment maintenance by running a “dry site”. This involves using off-site facilities, performing work in designated areas only, providing cover for materials stored outside, checking for leaks and spills, containing and cleaning up spills immediately, and training employees and subcontractors.

APPROACH

- Keep vehicles and equipment clean; do not allow excessive build-up of oil and grease.
- Use off-site repair shops as much as possible. Maintaining vehicles and equipment outdoors or in areas where vehicles or equipment fluids may spill or leak into the ground can pollute storm water. If you maintain a large number of vehicles or pieces of equipment, consider using an off-site repair shop. These businesses are better equipped to handle vehicle fluids and spills properly. Performing this work off-site can also be economical by eliminating the need for a separate maintenance area.
- If maintenance must occur on-site, use designated areas, located away from drainage courses, to prevent the run-on of storm water and the runoff of spills.
- Always use secondary containment, such as a drain pan or drop cloth, to catch sills or leaks when removing or changing fluids.
- Place a stockpile of spill cleanup materials where it will be readily accessible.
- Use adsorbent materials on small spills rather than hosing down or burying the spill. Remove the adsorbent materials promptly and dispose of properly.
- Regularly inspect on-site vehicles and equipment for leaks, and repair immediately.
- Check incoming vehicles and equipment (including delivery trucks and employee and subcontractor vehicles) for leaking oil and fluids. Do not allow leaking vehicles or equipment on-site.
- Segregate and recycle wastes, such as greases, used oil or oil filters, antifreeze, cleaning solutions, automotive batteries, hydraulic, and transmissions fluids.
- Train employees and subcontractors in proper maintenance and spill cleanup procedures.
- For a quick reference on disposal alternatives for specific wastes, see Table 5-1.

TARGET POLLUTANTS

● Likely to have significant impact		○ Probable Low or Unknown impact	
○ Sediment	○ Nutrients	● Toxic Materials	
● Oil & Grease	○ Floatable Materials	○ Other Construction Waste	



### **BMP 14: EMPLOYEE/SUBCONTRACTOR TRAINING**

#### *DESCRIPTION*

Employee/subcontractor training is not so much, a best management practice, as it is a method by which to implement BMPs. This fact sheet highlights the importance of training and of integrating the elements of employee/subcontractor training from the individual source controls into a comprehensive training program as part of the Erosion and Sediment Control Plan (ESCP).

The specific employee/subcontractor training aspects of each of the source controls are highlighted in the individual fact sheets. The focus of this fact sheet is more general, and includes the overall objectives and approach for assuring employee/subcontractor training in storm water pollution prevention. Accordingly, the organization of this fact sheet differs from the other fact sheets in the chapter.

#### **OBJECTIVES**

Employee/subcontractor training should be based on four objectives:

- Promote a clear identification and understanding of the problem, including activities with the potential to pollute storm water;
- Identify solutions (BMPs);
- Promote employee/subcontractor ownership of the problems and the solutions; and
- Integrate employee/subcontractor feedback into training and BMP implementation.

#### **APPROACH**

- Integrate training regarding storm water quality management with existing training programs that may be required by other regulations, the Hazardous Waste Operations and Emergency Response standard (29CFR 1910.120), the Spill Prevention Control and Countermeasure Plan (40CFR 112).
- Train employees/subcontractors in standard operating procedures and spill cleanup techniques described in the Pollution Control Plan. Employee/subcontractors trained in spill containment and cleanup should be present during the loading/unloading and handling of materials.
- Personnel who use pesticides should be trained in their use.
- Educating off-site contractors and subcontractors supports the efforts of well-trained employees.
- Consider posting the quick reference table around the job site or in the on-site office trailer to reinforce training.
- Train employees/subcontractors in standard operating procedures and spill cleanup techniques described in the fact sheets. Employees/subcontractors trained in spill containment and cleanup should be present during the loading/unloading and handling of materials.
- Personnel who use pesticides should be trained in their use. The Oregon Department of Pesticide Regulation and county agricultural commissioner's license pesticide dealers, certify pesticide applicators, and conduct on-site inspections.
- Proper education of off-site contractors is often overlooked. The conscientious efforts of well-trained employee/subcontractors can be lost by unknowing off-site contractors, so make sure they are well informed about what they are expected to do on-site.



### REFERENCES

Blueprint for a Clean Bay-Construction-Related Industries: Best Management Practices for Storm Water Pollution Prevention; Santa Clara Valley Nonpoint Source Pollution Control Program, 1992

Storm Water management for Construction Activities, Developing Pollution Prevention Plans and Best Management Practices, EPA 832-R-92005; USEPA, April 1992.

Hot-mix Asphalt Paving Handbook, U.S. Army Corps of Engineers, Ac 150/5370-14, Appendix July 1991

Best Management Practices and Erosion Control Manual for Construction Sites; Flood Control District of Maricopa County, AZ. September 1992

Coastal Nonpoint Pollution Control Program: Program Development and Approval Guidance, Working Group Working Paper; USEPA, April 1992

Processes, Procedures, and Methods to Control Pollution Resulting from all Construction Activity; USEPA, 430/0-73-007,1973.

Swisher, R.D., 1987. Surfactants Biodegradation, Marcel Decker Corporation

## **CHAPTER 6**

### **INSPECTION AND MAINTENANCE**

Erosion and sediment control (ESC) measures are required and are used for the purpose of protecting sensitive areas such as, streams, rivers, lakes, wetlands and the MS4 system. Inspection and maintenance of ESC measures throughout the life of the project is imperative to ensure their performance. Unless the measures are properly installed and maintained, there is a strong chance of failure during the construction period.

#### **6.1 Permittee Site Inspector**

The owner of the site shall designate a competent person as the Permittee Site Inspector (PSI). Inspections must be conducted by a person knowledgeable in the principles and practice of erosion and sediment controls and possess the skills to assess conditions at the construction site that could affect stormwater quality. The inspector should be knowledgeable in the correct installation of the erosion and sediment controls, and is able to assess the effectiveness of any sediment and erosion control measures selected to control the quality of stormwater discharges from the construction activity.

The PSI shall be responsible for assuring the implementation of the ESCP and have the authority to immediately mobilize the necessary personnel and equipment to correct and modify erosion prevention and sediment controls when necessary. Check with local jurisdiction for specific requirements, permits and inspection requirements.

Duties of the PSI include:

- Provide name and 24-hour contact information of PSI
- Manage and insure proper implementation of the ESCP.
- Accompany the Agency in a field review of the ESCP prior to the beginning of work.
- Conduct inspections. Check local and/or state regulations for inspection frequency and requirements.
- Mobilize crews to make immediate repairs to the controls or install controls during working and non-working hours.
- Complete erosion control monitoring forms after each inspection.
- Maintain up-to-date ESCP throughout the life of the project, available for review upon request.
- Prepare a contingency plan in preparation for emergencies and wet weather conditions.
- Accompany the Agency on inspections and, if requested, on inspection made by other regulating Agencies.
- In the case of ineffective controls, the PSI shall record measures to clean up significant amounts of sediment. Should a control measure not function effectively, one or more of the following tasks should be performed.
  - Immediately repair the control.
  - Replace the control.
  - Provide additional controls.

### 6.2 Pre-Construction Meeting

Larger more complex construction sites such as, subdivisions, commercial, and highway projects require ongoing, very detailed inspection and maintenance for longer periods. For that very reason alone, pre-construction meetings are vital and should be scheduled prior to any clearing, grading, or utility activities. Equally important is who should attend. Along with the inspector and engineer, the contractors grading and utility superintendent should be present. The PSI, contractor and regulatory inspector should carefully review the ESCP prior to the pre-construction meeting to understand what is required. Implementing the ESCP and assuring its performance may involve significant expense if done incorrectly. The following pre-construction activities should be required.

- Prior to the pre-construction meeting, review and comment on the ESCP.
- During the pre-construction meeting, review all comments and concerns.
- Prohibit clearing and grading operations prior to ESCP approval and implementation.
- Tentatively locate construction accesses.
- Delineate clearing limits, drainage courses, easements, setbacks, wetlands, and other sensitive areas and their buffers.

The pre-construction meeting provides an opportunity for the contractor to discuss the plan with the inspector and learn which elements of the ESCP deserve the most attention. Adjustments to improve performance or make installation easier and maintenance more reliable may also be discussed.

The pre-construction meeting is also an opportunity to discuss the inspection schedule and procedures. Key points to consider in the pre-construction meeting are:

- Pollution Control Plan for contractor operations.
- Discuss the responsibilities and qualifications of the individuals that are designated as the PSI. Method to be used to document the updates to the ESCP.
- Adjacent areas that need special protection from sedimentation, particularly environmentally sensitive areas such as wetlands, stream crossings, channel, and water disposal outlets.
- Discuss drainage aspects of the site (both pre and post construction).
- Location of erosion and sediment control practices and their implementation.
- Sequence of construction activities to limit areas of exposed soils.
- Sequence of installation with respect to the construction schedule.
- Surface stabilization plans, temporary and permanent seeding.
- Construction schedule and any anticipated shutdown periods.
- Maintenance plans and the contractor's procedure for monitoring performance.
- Location of all borrow and disposal areas.
- Emergency or contingency plans.
- Any special requirements identified in permits, reports or environmental assessments.
- Monitoring form used and availability.

### 6.2.1 Modified ESCP

All projects will include an ESCP prepared prior to the start of any construction or other land disturbing activities. This plan may require a registered engineer's approval. This plan is only a guide and is unlikely to have addressed all erosion problems for the project adequately. The ESCP included in the plan set should not be followed blindly. It is the owner or PSI's responsibility to make modifications to the plan as necessary to prevent erosion and sediment from leaving the site. The ESCP is a living document that should be updated with the changing conditions of the site and document the BMPs installed at any one time. As modifications to the ESCP take place, it is extremely important to secure the interest of all parties. Communications between the contractor, designated person and inspector is vital.

Depending upon the level of modification, the design engineer is responsible for submitting changes to the ESCP to the local jurisdiction. Check with DEQ, the DEQ Local Agent or local jurisdiction for specific requirements.

### 6.2.2 Construction Schedule Review

The construction schedule, in general, should include the following:

- Timing of activities to limit seasonal and weather impacts.
- Timing of wet weather work and temporary work shut down.
- Time of activities to meet "in-water" work restrictions.
- Erosion prevention and sediment controls shown on the plans should be installed before ground-disturbing activities begin.
- Permanent facilities, such as sediment traps and basins, which will be used during construction as temporary measures should be installed.
- Retention of temporary perimeter controls until all upstream areas are finally stabilized.
- Timing of soil stabilization such as seeding, planting, etc.

### 6.3 Installation of BMPs

It must be understood that installation is equally important to the value and success of the materials. If installed incorrectly, even the best materials will fail causing more damage and additional expense to the project. For this reason alone, installation procedures should be followed very closely.

Installation of all base measures shall be inspected by Permittee Site Inspector (PSI) and any deficiencies corrected prior to the start of land disturbing activities. Subsequent inspections of any additional installations should also be made throughout the life of the project as needed. Base measures need to also be inspected by the local jurisdiction with erosion control authority.

The agency inspector, contractor or PSI should be familiar with installations details for each BMP used on the project. Details for the installation of all specified BMPs should be provided in the ESCP. Installation details for BMPs are also provided in Chapter 4 of this manual.

### 6.4 Inspection Requirements

The owner or designated person (PSI) shall be required to provide ongoing inspection of erosion and sediment control measures throughout the life of the project. All development site inspections should be recorded on an approved monitoring form and readily available. The effectiveness of each BMP at every location on site should be documented on the monitoring form, and general observations on site conditions should be recorded. Information provided on the form is useful for tracking repairs and demonstrating permit compliance. It is noteworthy that in the event of permit violations or subsequent enforcement actions, the information recorded on the form, along with photographs and videos may be used to evaluate the responsibility of involved parties.

Minimum inspection requirements including frequency will vary, therefore the owner or PSI will need to refer to local or state regulations for required inspection frequency.

#### 6.4.1 Inspection Checklist

The sample Inspection Checklist included in Appendix B may be used by Agency representatives when inspecting erosion and sediment controls on a project site. The checklist is intended to summarize the key elements of a successful erosion and sediment control program. Topics on the checklist include:

- Schedule Review
- Erosion and Sediment Control Plan
- Erosion and Pollution Control Manager
- Sensitive Areas
- Contingency Plans
- Materials On-Hand
- Maintenance
- Monitoring Forms
- Slope Protection and Stabilization
- Plan Revisions and Modifications
- BMP Evaluation
- Additional Items

#### 6.4.2 Inspection of Work Restriction Areas

All construction projects are required to restrict certain types of work, which may contribute to sediment-laden water leaving the project boundaries or entering waterways. The following work restrictions need to be inspected prior to the start of work and throughout the life of the project.

- 1) **Flag Clearing Limits:** Construction site clearing limits will be clearly flagged in accordance with the approved plans. No ground disturbance is permitted beyond the flagged boundary. Flagging should be maintained for the duration of construction.
- 2) **Perimeter Controls before Grubbing:** all appropriate perimeter controls should be installed prior to any major site grubbing operation. Perimeter controls include interceptor ditches, berms infill areas, and sediment fences. Perimeter controls are especially important when protecting existing streams, wetlands and natural areas.

- 3) **Wet Weather Plan and Schedule:** Prior to wet weather construction work and before temporary work suspension for winter, the contractor, or designated person should meet with the Agency to review and update the ESCP and to develop a schedule to assure that appropriate controls are implemented and maintained during wet weather and suspended work periods.
- 4) **Limit Disturbed Areas:** If soil erosion and sediment resulting from construction activities is not effectively controlled, the Agency will limit the amount of disturbed areas that can be effectively controlled.
- 5) **Install BMPs Early:** Erosion and sediment control features should be incorporated into the projects at the earliest practicable time. All erosion and sediment control measures should be installed according to the approved implementation schedule.
- 6) **Stop Work:** Failure to control erosion and or pollution shall be cause for the Agency to stop all construction work until measures have been taken to bring all construction into compliance.

### 6.5 Stabilization Requirements

All soils that are exposed and disturbed by construction-related activities should be stabilized according to the following time frames.

- All seeding applications must be completed and established prior to wet weather season
- Wet weather season – October 1<sup>st</sup> through May 31<sup>st</sup>
- Soils exposed during wet weather season as a result of construction must be covered at the end of each day

### 6.6 Erosion Control Contingency Items

It is a requirement that all construction sites have materials on hand as a contingency in the event of a failure or when required to shore up BMPs installed as part of the ESCP.

The contingency items may also be used at the discretion of the project inspector to strengthen the erosion control measures as needed during construction.

The following are examples of materials to be kept on the project site for use in emergencies.

- 100 ft. of sediment fence
- 260 sq. ft. of plastic sheeting
- 1,000 ft. of rope
- 50 empty sand bags (to be filled as needed)
- 10 bales of straw (used for ground cover)
- 10 bio-filter bags with stakes

### 6.7 Maintenance

Erosion and sediment controls must be maintained in good working order at all times in order to function as intended. These controls must be maintained in place until the Agency issues notification of acceptance of permanent stabilization.

Typical maintenance activities, guidelines and failure modes for BMPs are discussed in Chapter 4 of this manual. The inspector should be familiar with maintenance requirements for each BMP used on the project. It is noteworthy that maintenance activities and frequencies vary among the different BMPs and will depend largely on weather and other site conditions. In general, the more effective erosion prevention measures are, the less maintenance will be required for sediment controls.

### **6.7.1 Sediment Removal**

Sediment shall be removed and the controls upgraded or repaired as outlined in Chapter 4 BMP maintenance, or as directed. In the event of continuous rainfall over a 24-hour period, or other circumstances that preclude equipment operation in that area, additional sediment controls may need to be hand-carried, and installed in accordance with best management practices and as approved by the Agency. Sediment will need to be removed from controls such as sediment fences, sediment barriers, check dams, inlet protection, and sediment traps when the sediment buildup has reached 1/3 the exposed height of the control or storage depth. Rock filters and filter berm material shall be replaced with new rock material when sediment reduces the filtering capacity by 50 percent. Rock or other material specified shall be added or removed as needed to maintain proper function of the entrance areas. All paved areas shall be kept clean (by mechanical means) for the duration of the project.

### **6.7.2 Sediment Disposal**

Removed sediment shall be placed in a non-erodible area within the construction site, or removed and disposed of off-site in accordance with all federal, state, and local laws and ordinances. Sediment-laden water shall not be flushed into the storm water or sanitary system.

## **6.8 Winterization**

The wet weather season is October 1 through May 31. Prior to working during the wet weather season, and before consideration of work suspension for winter, the contractor should meet with the Agency to review and update the ESCP and to develop a schedule to assure that appropriate controls are implemented and maintained during wet weather season and during any possible work suspension periods. Winter preparations should begin several weeks prior to the wet weather season. Refer to Chapter 4 for information on common best management practices.

## **6.9 Designer/Inspector Tool Box**

Several worksheets are provided in Appendix C to aid designers and inspectors in determining and verifying the quality and quantity of various erosion control BMPs. These are especially useful when verifying the application rates of various mulch and hydraulically applied products. Appendix C includes the following:

- Slope Inclination Conversions
- Metric Conversions Table
- Straw Mulch Application Worksheet
- Hydraulic Application Equations

## CHAPTER 6: INSPECTION AND MAINTENANCE

---

- Wood Fiber Mulch Hydraulic Application Worksheet
- Seed / Fertilizer Hydraulic Application Worksheet
- Hydraulic Application Example Problems



This page intentionally left blank.

# APPENDICES

# Appendix A

Grading & Erosion Control Information

Erosion Control Notes

Erosion and Sediment Control Plan Symbols

# GRADING & EROSION CONTROL INFORMATION

<b>GENERAL CONTRACTOR</b> Name: _____ Address: _____ Phone #: _____	<b>CONSTRUCTION ACTIVITY</b> Project #: _____ Project Name: _____
<b>EXCAVATION CONTRACTOR</b> Name: _____ Address: _____ Phone #: _____	<b>SITE ADDRESS</b> Nearest Cross Streets: _____ _____
<b>OWNER/APPLICANT</b> Name: _____ Address: _____ Phone #: _____	<b>DRAINAGE / WATERWAY</b> Name of nearest stream, creek, river: _____
<b>24-HOUR EMERGENCY CONTACT</b> Name: _____ Address: _____ Phone #: _____	<b>SOIL DISPOSAL</b> Exporting Soil?            Y            N Address of Site: _____ _____

**I agree to comply with the “Erosion Prevention and Sediment Control Planning and Design Manual” and will construct and maintain ESC measures to contain Sediment on the construction site.**













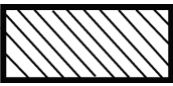

\_\_\_\_\_  
**Owner/Applicant Signature**

\_\_\_\_\_  
**Date**

## STANDARD EROSION AND SEDIMENT CONTROL PLAN DRAWING NOTES:

1. WHEN RAINFALL AND RUNOFF OCCURS DAILY INSPECTIONS OF THE EROSION AND SEDIMENT CONTROLS AND DISCHARGE OUTFALLS MUST BE PROVIDED BY SOME ONE KNOWLEDGEABLE AND EXPERIENCED IN THE PRINCIPLES, PRACTICES, INSTALLATION, AND MAINTENANCE OF EROSION AND SEDIMENT CONTROLS WHO WORKS FOR THE PERMITTEE.
2. CONSTRUCTION ACTIVITIES MUST AVOID OR MINIMIZE EXCAVATION AND CREATION OF BARE GROUND FROM OCTOBER 1 THROUGH MAY 31 EACH YEAR.
3. DURING WET WEATHER PERIOD, TEMPORARY STABILIZATION OF THE SITE MUST OCCUR AT THE END OF EACH WORK DAY.
4. SEDIMENT CONTROLS MUST BE INSTALLED AND MAINTAINED ON ALL DOWN GRADIENT SIDES OF THE CONSTRUCTION SITE AT ALL TIMES DURING CONSTRUCTION. THEY MUST REMAIN IN PLACE UNTIL PERMANENT VEGETATION OR OTHER PERMANENT COVERING OF EXPOSED SOIL IS ESTABLISHED.
5. ALL ACTIVE INLETS MUST HAVE SEDIMENT CONTROLS INSTALLED AND MAINTAINED AT ALL TIMES DURING CONSTRUCTION. UNLESS OTHERWISE APPROVED, A SURFACE MOUNTED AND ATTACHABLE, U-SHAPED FILTER BAG IS REQUIRED FOR ALL CURB INLET CATCH BASINS.
6. SIGNIFICANT AMOUNTS OF SEDIMENT WHICH LEAVES THE SITE MUST BE CLEANED UP WITHIN 24 HOURS AND PLACED BACK ON THE SITE AND STABILIZED OR PROPERLY DISPOSED. THE CAUSE OF THE SEDIMENT RELEASE MUST BE FOUND AND PREVENTED FROM CAUSING A RECURRENCE OF THE DISCHARGE WITHIN THE SAME 24 HOURS. ANY IN-STREAM CLEAN UP OF SEDIMENT SHALL BE PERFORMED ACCORDING TO THE OREGON DEPARTMENT OF STATE LANDS REQUIRED TIME FRAME.
7. SEDIMENT MUST NOT BE INTENTIONALLY WASHED INTO STORM SEWERS, DRAINAGE WAYS, OR WATER BODIES.
8. SEDIMENT MUST BE REMOVED FROM BEHIND ALL SEDIMENT CONTROL MEASURES WHEN IT HAS REACHED A HEIGHT OF 1/3RD THE BARRIER HEIGHT, AND PRIOR TO THE CONTROL MEASURES REMOVAL.
9. CLEANING OF ALL STRUCTURES WITH SUMPS MUST OCCUR WHEN THE SEDIMENT RETENTION CAPACITY HAS BEEN REDUCED BY 50% AND AT COMPLETION OF PROJECT.
10. ANY USE OF TOXIC OR OTHER HAZARDOUS MATERIALS MUST INCLUDE PROPER STORAGE, APPLICATION, AND DISPOSAL.
11. THE PERMITTEE MUST PROPERLY MANAGE HAZARDOUS WASTES, USED OILS, CONTAMINATED SOILS, CONCRETE WASTE, SANITARY WASTE, LIQUID WASTE, OR OTHER TOXIC SUBSTANCES DISCOVERED OR GENERATED DURING CONSTRUCTION.
12. THE APPLICATION RATE OF FERTILIZERS USED TO REESTABLISH VEGETATION MUST FOLLOW MANUFACTURER'S RECOMMENDATIONS. NUTRIENT RELEASES FROM FERTILIZERS TO SURFACE WATERS MUST BE MINIMIZED. TIME RELEASE FERTILIZERS SHOULD BE USED AND CARE SHOULD BE MADE IN APPLICATION OF FERTILIZERS WITHIN ANY WATER WAY RIPARIAN ZONE.
13. OWNER OR DESIGNATED PERSON SHALL BE RESPONSIBLE FOR PROPER INSTALLATION AND MAINTENANCE OF ALL EROSION AND SEDIMENT CONTROL MEASURES, IN ACCORDANCE WITH CURRENT CLEAN WATER SERVICES STANDARDS AND STATE, AND FEDERAL REGULATIONS.
14. PRIOR TO ANY LAND DISTURBING ACTIVITIES, THE BOUNDARIES OF THE CLEARING LIMITS, VEGETATED BUFFERS, AND ANY SENSITIVE AREAS SHOWN ON THIS PLAN SHALL BE CLEARLY DELINEATED IN THE FIELD. UNLESS OTHERWISE APPROVED, NO DISTURBANCE IS PERMITTED BEYOND THE CLEARING LIMITS. THE OWNER/PERMITTEE MUST MAINTAIN THE DELINEATION FOR THE DURATION OF THE PROJECT.  
NOTE: VEGETATED CORRIDORS TO BE DELINEATED WITH ORANGE CONSTRUCTION FENCE OR APPROVED EQUAL.
15. PRIOR TO ANY LAND DISTURBING ACTIVITIES, THE BMPS THAT MUST BE INSTALLED ARE GRAVEL CONSTRUCTION ENTRANCE, PERIMETER SEDIMENT CONTROL, AND INLET PROTECTION. THESE BMPS MUST BE MAINTAINED FOR THE DURATION OF THE PROJECT.
16. IF VEGETATIVE SEED MIXES ARE SPECIFIED, SEEDING MUST TAKE PLACE NO LATER THAN SEPTEMBER 1ST; THE TYPE AND PERCENTAGES OF SEED IN THE MIX ARE AS IDENTIFIED ON THE PLANS OR AS SPECIFIED BY THE DESIGN ENGINEER.
17. WATER-TIGHT TRUCKS MUST BE USED TO TRANSPORT SATURATED SOILS FROM THE CONSTRUCTION SITE. AN APPROVED EQUIVALENT IS TO DRAIN THE SOIL ON SITE AT A DESIGNATED LOCATION USING APPROPRIATE BMPS; SOIL MUST BE DRAINED SUFFICIENTLY FOR MINIMAL SPILLAGE.
18. ALL PUMPING OF SEDIMENT LADEN WATER MUST BE DISCHARGED OVER AN UNDISTURBED, PREFERABLY VEGETATED AREA, AND THROUGH A SEDIMENT CONTROL BMP (I.E. FILTER BAG).
19. THE ESC PLAN MUST BE KEPT ONSITE. ALL MEASURES SHOWN ON THE PLAN MUST BE INSTALLED PROPERLY TO ENSURE THAT SEDIMENT LADEN WATER DOES NOT ENTER A SURFACE WATER SYSTEM, ROADWAY, OR OTHER PROPERTIES.
20. THE ESC MEASURES SHOWN ON THIS PLAN ARE THE MINIMUM REQUIREMENTS FOR ANTICIPATED SITE CONDITIONS. DURING THE CONSTRUCTION PERIOD, THESE MEASURES SHALL BE UPGRADED AS NEEDED TO MAINTAIN COMPLIANCE WITH ALL REGULATIONS.
21. WRITTEN ESC LOGS ARE SUGGESTED TO BE MAINTAINED ONSITE AND AVAILABLE TO DISTRICT INSPECTORS UPON REQUEST.
22. IN AREAS SUBJECT TO WIND EROSION, APPROPRIATE BMPS MUST BE USED WHICH MAY INCLUDE THE APPLICATION OF FINE WATER SPRAYING, PLASTIC SHEETING, MULCHING, OR OTHER APPROVED MEASURES.
23. ALL EXPOSED SOILS MUST BE COVERED DURING WET WEATHER PERIOD.

## Erosion Prevention and Sediment Control Symbols

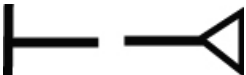
	<b>Brush Barrier</b>
	<b>Check Dam</b>
	<b>Compost Blanket</b>
	<b>Construction Entrance</b>
	<b>Diversion Dike</b>
	<b>Diversion Swale</b>
	<b>Diversion Dike/Swale</b>
	<b>Erosion Control Matting</b>
	<b>Filter Berm</b>
	<b>Inlet Protection</b>
	<b>Outlet Protection</b>
	<b>Sediment Barrier</b>
	<b>Sediment Fence</b>
	<b>Sediment Mat</b>
	<b>Sediment Trap</b>
	<b>Seeding &amp; Mulching</b>
	<b>Temporary Slope Drains</b>

This page intentionally left blank.

# Appendix B

Erosion Control Inspection Log

Inspector Checklist For Erosion Control



## Erosion Control Inspection Log

Project Name: \_\_\_\_\_

Date: \_\_\_\_\_ Time: \_\_\_\_\_ Weather: \_\_\_\_\_ Rainfall In the Last 24 Hours: Yes \_\_\_\_\_ No \_\_\_\_\_

Site Active: Yes \_\_\_\_\_ No \_\_\_\_\_ Days Since Last Inspection: \_\_\_\_\_

Inspection Type: Initial Inspection \_\_\_\_\_ Regular Inspection \_\_\_\_\_ Final \_\_\_\_\_ Active Storm Water Runoff \_\_\_\_\_ Other \_\_\_\_\_

Observations: \_\_\_\_\_

\_\_\_\_\_  
\_\_\_\_\_

(More Space on Back)

Corrective Actions Taken/Needed: \_\_\_\_\_

\_\_\_\_\_  
\_\_\_\_\_

(More Space on Back)

Have Any Changes Been Made to the ESCP: Yes \_\_\_\_\_ No \_\_\_\_\_

If Yes, What Changes Have Been Made: \_\_\_\_\_

\_\_\_\_\_  
\_\_\_\_\_

Have The Changes Been Documented: Red Lines: Yes \_\_\_\_\_ No \_\_\_\_\_ Action Plan: Yes \_\_\_\_\_ No \_\_\_\_\_

Inspected By: Print Name: \_\_\_\_\_ Title: \_\_\_\_\_

Signature: \_\_\_\_\_

\*Additional Comment Space on Back\*

Observations: (Continued)

---

---

---

---

---

---

---

---

---

---

Corrective Actions Taken/Needed: (Continued)

---

---

---

---

---

---

---

---

---

---

# **INSPECTION CHECKLIST FOR EROSION CONTROL**

## **□ SCHEDULE**

Have you looked at the Contractors Schedule and determined any conflicts?

- ✓ Install necessary Best Management Practices (BMPs) prior to any earthwork beginning.
- ✓ Are earthwork operations being performed in wet weather season with soils that are highly erosive?
- ✓ Grubbing of areas that will be worked on much later should be delayed
- ✓ Staging of project may require staging of erosion control measures
- ✓ Is seeding scheduled before the end of the seed dates?
- ✓ Are there “In-Stream work areas that may alter contractor’s schedule?
- ✓ When will the contractor remove BMPs?

## **□ EROSION AND SEDIMENT CONTROL PLAN (ESCP)**

- ✓ Walk project during preliminary or advanced plan review and look for potential erosion problems
- ✓ Have you reviewed the Contractor’s Erosion Control Plan to determine if it is adequate or makes sense? The ESCP included in the bid package may need modifications to address site conditions or staging
- ✓ Walk project with PSI prior to any earthwork looking for needed modifications of ESCP
- ✓ Is the ESCP being kept up-to-date?
- ✓ Is the ESCP kept on-site? Where?
- ✓ What is contractor’s erosion control plan for offsite borrow sources and waste areas?

## **□ EROSION AND SEDIMENT CONTROL MANAGER (PSI)**

Have you met and talked with the person identified as the PSI?

- ✓ Do you believe this person has adequate knowledge to perform this work?
- ✓ Does this person understand all the required duties of the PSI?
- ✓ Does this person have the authority to direct resources and make changes in an emergency situation?

## **□ SENSITIVE AREAS**

Are there sensitive areas, which require “extra” attention?

- ✓ Have they been adequately addressed on the ESCP?
- ✓ Will these sensitive areas require more monitoring?

## **□ CONTINGENCY PLAN**

- ✓ Is there a contingency plan for unexpected events?
- ✓ What is the plan for stabilization of earthwork performed after seeding dates?

## **□ MATERIALS ON-HAND**

It may be difficult to get Erosion Control materials in the middle of the wet season. It is easier to deal with erosion before it happens rather than after.

- ✓ Does the Contractor have adequate materials on hand to cover each phase of work they plan on performing?

□ **MAINTENANCE**

- ✓ Consider access for maintenance of BMPs. Place where they are easy to maintain if you have a choice
- ✓ Are installed erosion and sediment controls in good working order?
- ✓ Are catch basins cleaned out when more than 6 inches of sediment depth accumulates?
- ✓ At sediment fences, barriers, check dams, inlet protection cleaned out when sediment reaches 1/3 of the storage depth?
- ✓ Are construction entrances maintained with fresh rock to prevent tracking of sediment onto pavement?

□ **MONITORING FORMS**

- ✓ Are you getting Erosion Control Weekly reports as often as they should be filed from the PSI?
- ✓ Are the forms complete and adequately represent site conditions and work performed?
- ✓ Are forms on-site with the “Up-to-Date Plan”?

□ **SLOPE PROTECTION & STABILIZATION**

- ✓ All highly sensitive areas
- ✓ Permanently finish slopes from top down and seed as you go!
- ✓ Track walk slopes to provide loosened soil and hold seed
- ✓ Temporarily stabilize unfinished earthwork scheduled for re-disturbance at a later date (i.e. straw mulch, chemical soil stabilizers, plastic sheeting, matting, etc.)

□ **PLANS ARE ONLY A GUIDE**

What’s best for your project is what works on your project. No designer can sit in an office and determine what works on your project. It may require trial and error. The plans are a toolbox with available tools. You may have to create and modify these tools to satisfy the conditions

□ **IT’S NOT WORKING!!!**

Are the BMPs working? If not, are the facilities attempting to prevent erosion before it starts?

□ **ADDITIONAL ITEMS**

- ✓ Go back to newly installed BMPs to check their performance
- ✓ How will contractor handle dust control or wind erosion?
- ✓ Will snow melt change runoff and drainage patterns?

## Appendix C

Metric Conversion Table

Slope Conversion Table

Seed or Fertilizer Hydraulic Application Table A-1

Wood Fiber Mulch Hydraulic Application Table C-1, C-2

Hydraulic Application Worksheet

Example Mulch/Seed Worksheet

## Metric Conversion Tables

Measurement in:	From English Units:	To Metric Units:	Multiply By
Length	inch (in)	millimeter (mm)	25.40
	foot (ft)	meter (mm)	0.3048
	yard (yd)	meter (mm)	0.9144
	mile (mi)	kilometer (km)	1.609
Area	in <sup>2</sup>	mm <sup>2</sup>	645.2
	ft <sup>2</sup>	m <sup>2</sup>	0.0929
	yd <sup>2</sup>	m <sup>2</sup>	0.8361
	mi <sup>2</sup>	km <sup>2</sup>	2.590
	acre	hectare (ha)	0.4047
	acre	m <sup>2</sup>	4047

Quantity	From SI Units	To English Units	Divide By
Length	km	mile	1.609
	m	yard	0.9144*
	m	foot	0.3048*
	mm	inch	25.4*
Area	km <sup>2</sup>	square mile	2.59
	m <sup>2</sup>	acre	4047
	hectare	acre	0.404
	m <sup>2</sup>	square yard	0.836
	m <sup>2</sup>	square foot	0.092
	mm <sup>2</sup>	square inch	645.2

## Abbreviations

L	liter
ha	hectares
kg	Kilogram=1x10 <sup>3</sup> grams
m	meter
km	kilometer=1x10 <sup>3</sup> meters

## SLOPE CONVERSION TABLE

Rise:Run	% Grade	Angle Degree
1:00	1.0	0.6
1:90	1.1	0.6
1:80	1.3	0.7
1:70	1.4	0.8
1:60	1.7	1.0
1:50	2.0	1.1
1:40	2.5	1.4
1:35	2.9	1.6
1:30	3.3	1.9
1:25	4.0	2.3
1:20	5.0	2.9
1:19	5.3	3.0
1:18	5.6	3.2
1:17	5.9	3.4
1:16	6.3	3.6
1:15	6.7	3.8
1:14	7.1	4.1
1:13	7.7	4.4
1:12	8.3	4.8
1:11	9.1	5.2
1:10	10.0	5.7
1:9	11.1	6.3
1:8	12.5	7.1
1:7	14.3	8.1
1:6	16.7	9.5
1:5	20.0	11.3
1:4	25.0	14.0
1:3	33.3	18.4
1:2	50.0	26.6
1:1	100.0	45.0

**How to calculate Slope:**  $\frac{\text{Rise or (v) vertical change elevation (feet)}}{\text{Run or (h) horizontal distance (feet)}}$

**Example:** Divide rise by run to get your calculated slope %

$$\frac{15v}{50h} \quad * \text{ Divide } 15v \text{ by } 50h \text{ to get } .30 \text{ or } 30\%$$

**TableA-1**

**Seed or Fertilizer Hydraulic Application**

Application Load (Wst) Pounds	Area of Coverae (A)													
	Application Rates of Pure Live Seed (Rs)													
	20 lb/acre		40 lb/acre		60 lb/acre		80 lb/acre		100 lb/acre		200 lb/acre		400 lb/acre	
	acre	ft. <sub>L</sub>	acre	ft. <sub>L</sub>	acre	ft. <sub>L</sub>	acre	ft. <sub>L</sub>	acre	ft. <sub>L</sub>	acre	ft. <sub>L</sub>	acre	ft. <sub>L</sub>
10	0.50	21,780	0.25	10,890	0.17	7,260	0.13	5,445	0.10	4,356	0.05	2,178	0.03	1,089
20	1.00	43,560	0.50	21,780	0.33	14,520	0.25	10,890	0.20	8,712	0.10	4,356	0.05	2,178
30	1.50	65,340	0.75	32,670	0.50	21,780	0.38	16,335	0.30	13,068	0.15	6,534	0.08	3,267
40	2.00	87,120	1.00	43,560	0.67	29,040	0.50	21,780	0.40	17,424	0.20	8,712	0.10	4,356
50	2.50	108,900	1.25	54,450	0.83	36,300	0.63	27,225	0.50	21,780	0.25	10,890	0.13	5,445
60	3.00	130,680	1.50	65,340	1.00	43,560	0.75	32,670	0.60	26,136	0.30	13,068	0.15	6,534
70	3.50	152,460	1.75	76,230	1.17	50,820	0.88	38,115	0.70	30,492	0.35	15,246	0.18	7,623
80	4.00	174,240	2.00	87,120	1.33	58,080	1.00	43,560	0.80	34,848	0.40	17,424	0.20	8,712
90	4.50	196,020	2.25	98,010	1.50	65,340	1.13	49,005	0.90	39,204	0.45	19,602	0.23	9,801
100	5.00	217,800	2.50	108,900	1.67	72,600	1.25	54,450	1.00	43,560	0.50	21,780	0.25	10,890
120	6.00	261,360	3.00	130,680	2.00	87,120	1.50	65,340	1.20	52,272	0.60	26,136	0.30	13,068
140	7.00	304,920	3.50	152,460	2.33	101,640	1.75	76,230	1.40	60,984	0.70	30,492	0.35	15,246
160	8.00	348,480	4.00	174,240	2.67	116,160	2.00	87,120	1.60	69,696	0.80	34,848	0.40	17,424
180	9.00	392,040	4.50	196,020	3.00	130,680	2.25	98,010	1.80	78,408	0.90	39,204	0.45	19,602
200	10.00	435,600	5.00	217,800	3.33	145,200	2.50	108,900	2.00	87,120	1.00	43,560	0.50	21,780
220	11.00	479,160	5.50	239,580	3.67	159,720	2.75	119,790	2.20	95,832	1.10	47,916	0.55	23,958
240	12.00	522,720	6.00	261,360	4.00	174,240	3.00	130,680	2.40	104,544	1.20	52,272	0.60	26,136
260	13.00	566,280	6.50	283,140	4.33	188,760	3.25	141,570	2.60	113,256	1.30	56,628	0.65	28,314
280	14.00	609,840	7.00	304,920	4.67	203,280	3.50	152,460	2.80	121,968	1.40	60,984	0.70	30,492
300	15.00	653,400	7.50	326,700	5.00	217,800	3.75	163,350	3.00	130,680	1.50	65,360	0.75	32,670

"Application Load" is in Pure Live Seed.

Gross weight of seed can be converted by the Pure Live Seed (PLS) Rate [%Purityx % Germination = %PLS; Wsf = Gross Weight x %PLS]

To evaluate mulch tracer material, use Table C-1.



## Wood Fiber Mulch Hydraulic Application

<b>Table C-1</b>		<b>2,000lb/acre Application Rate (Rwr)</b>			<b>Area of Coverage (A)</b>	
<b>Wood Fiber</b>		<b>Water Required for Application</b>			<b>Area of Coverage (A)</b>	
(Ww1)		Average (Vwa)	Maximum (Vwml)			
		40 lbs mulch / 100aal water	50lbs mulch / 100aal water			
Pounds		*Gallons	*Gallons		fr	Acres
500		1,250	1,000		10,890	0.25
600		1,500	1,200		13,068	0.30
700		1,750	1,400		15,246	0.35
800		2,000	1,600		17,424	04 0
900		2,250	1,800		19,602	045
1,000		2,500	2,000		21,780	0.50
1,100		2,750	2,200		23,958	0.55
1,200		3 000	2 400		26 136	0.60
1,300		---	2,6 00		28,314	0.65
1,400		---	2,8 00		30,492	0.70
1,500		---	3 000		32,670	0.75

<b>Table C-2</b>		<b>2,500lb/acre Application Rate (Rwr)</b>			<b>Area of Coveraae (A)</b>	
<b>Wood Fiber</b>		<b>Water Required for ADDlication</b>			<b>Area of Coveraae (A)</b>	
(Ww1)		Average (Vwa)	Maximum (Vwml)			
		40 lbs mulch / 100aal water	50lbs mulch / 100aal water			
Pounds		*Gallons	*Gallons		tr	Acres
500		1,250	1,000		8,712	0.20
600		1,500	1,200		10,454	0.24
700		1 750	1 400		12,197	0.28
800		2,000	1,600		13,939	0.32
900		2,250	1,800		15,682	0.36
1,000		2,500	2 000		17,424	04 0
1,100		2,750	2,200		19,166	04 4
1,200		3,000	2,400		20,909	04 8
1,300		---	2,600		22,651	0.52
1,400		---	2,800		24,394	0.56
1,500		---	3,000		26,136	0.60

\* Largest Typical Hydro seeding equipment has a 3,000 gallon working volume.

# HYDRAULIC APPLICATION

## Wood Fiber Mulch Hydraulic Application

Average Water Required for Application

$$V_{wa} \text{ (gal)} = (W_{wf}) / (40\text{lbs mulch} / 100\text{gal water})$$

Maximum Water Required for Application

$$V_{wm} \text{ (gal)} = (W_{wf}) / (50\text{lbs mulch} / 100\text{gal water})$$

Area of Coverage

$$A \text{ (acre)} = (W_{wf} / R_{wf})$$

$$A \text{ (ft}^2\text{)} = (W_{wf} / R_{wf}) * (43,560 \text{ ft}^2\text{/acre})$$

Wood Fiber Application Rate (lb/acre)	$R_{wf}$
Weight or Mass of Wood Fiber (lbs)	$W_{wf}$
Average Water Requirement (gal)	$V_{wa}$
Maximum Water Requirement (gal)	$V_{wm}$
Area of Coverage (ft <sup>2</sup> ) & (acres)	A

## Seed or Fertilizer Hydraulic Application

Area of Coverage

$$A \text{ (acre)} = (W_{sf} / R_{sf})$$

$$A \text{ (ft}^2\text{)} = (W_{sf} / R_{sf}) * (43,560 \text{ ft}^2\text{/acre})$$

Seed or Fertilizer Application Rates (lb/acre)	$R_{sf}$
Weight or Mass of Seed or Fertilizer (lbs)	$W_{sf}$
Area of Coverage (ft <sup>2</sup> ) & (acres)	A

## **Example #1 (Mulch - Area of Coverage)**

**Given:** Required mulch application rate 2,000 lb/acre.  
Hydro Seeder with 1,800 gal working capacity.  
900 lbs of Wood Fiber to be applied over seeded area.

**Find:** Range of Area of Coverage.

**Answer:** Find the 2,000 lb/acre Application Rate Chart, Table C-3.

Using a 50 lbs / 100 gal mulch/water ratio:

Find 1,800 gal in the Maximum Water Required for Application column.

Follow this row over to the area columns.

One tank can cover **0.45 acre (19,602 ft<sup>2</sup>)**.

Using a 40 lbs / 100 gal mulch/water ratio:

Find 1,800 gal in the Average Water Required for Application column.

There isn't an 1,800 gal row, so interpolate between 1,750 gal and 2,000 gal.

Follow the 1,750 gal and 2,000 gal row over to the area columns.

At 1,750 gal, one tank can cover 0.35 acre (15,246 ft<sup>2</sup>).

At 2,000 gal, one tank can cover 0.40 acre (17,424 ft<sup>2</sup>).

One tank can cover  $1,800 \text{ gal} * ((0.40 \text{ acre} - 0.35 \text{ acre}) / (2,000 \text{ gal} - 1,750 \text{ gal}))$   
**0.36 acre (15,682 ft<sup>2</sup>)**.

## **Example #2 (Mulch - Materials Used)**

**Given:** 0.60 acre (26,136 ft<sup>2</sup>) area to be seeded.  
Required mulch application rate 1,200 lb/acre.  
Hydro Seeder with 2,500 gal working capacity.

**Find:** A) Amount of Mulch Required in lbs.  
B) Range of Water Required in gal.  
C) Number of Trips Required.

**Answer:** Find the 2,000 lb/acre Application Rate Chart, Table C-3.

A) Find 0.60 acre under the Area of Coverage column.

Follow the row over to the Wood Fiber column.

The wood fiber required by the area is **1,200 lb**.

B) Find 0.60 acre under the Area of Coverage column.

Follow the row to the Required Water for Application column.

Using a 50 lbs / 100 gal mulch/water ratio:

The water required for the area is **2,400 gal**.

Using a 40 lbs / 100 gal mulch/water ratio:

The water required for the area is **3,000 gal**.

C) Using a 50 lbs / 100 gal mulch/water ratio:

$(2,400 \text{ gal} / (2,500 \text{ gal/trip})) = \mathbf{1 \text{ trip}}$ .

Using a 40 lbs / 100 gal mulch/water ratio:

$(3,000 \text{ gal} / (2,500 \text{ gal/trip})) = 1.2 \text{ trips}$ , so use **2 trips**.

### **Example #3** (Seed - Area of Coverage)

**Given:** Seed Application Rate 40 lb/acre.  
200 lb of Seed is to be Applied.

**Find:** Area of Coverage.

**Answer:** Use the Seed or Fertilizer Hydraulic Application Chart, Table A-1.  
Find the 40 lb/acre application rate column.  
Find the 200 lb seed row.  
Determine where the column and the row intersect and record the area.  
For 40 lb/acre, the area of coverage is **5 acre (217,800 ft<sup>2</sup>)**.

Or

Use the Formula on the Hydraulic Application Equations Sheet.  
Find the area of coverage equation under the title Seed or Fertilizer Hydraulic Application.

The area equation is  $A \text{ (acre)} = W_{sf} / R_{sf}$

Area (acre) = (200 lb) / (40 lb/acre) = **5 acre**.

Area (ft<sup>2</sup>) = [(200 lb) / (40 lb/acre)] \* (43,560 ft<sup>2</sup>/acre) = **217,800 ft<sup>2</sup>**.

### **Example #4** (Seed - Materials Needed)

**Given:** Required Area of Coverage .13 acre (5,662.8 ft<sup>2</sup>).  
Seed Application Rate 200 lb/acre.

**Find:** Amount of Seed Required in lbs.

**Answer:** Use the Seed or Fertilizer Hydraulic Application Chart, Table A-1.  
Find the 200 lb/acre application rate column.  
Move down the list of areas to 0.13 acre.  
0.13 acre is not in this column, so interpolate.  
Find the area above and below 0.13 acre.  
Follow the row from the area to the Amount of Seed column.  
For 0.10 acre (4,356 ft<sup>2</sup>), the amount of seed is **20 lbs**.  
For 0.15 acre (6,534 ft<sup>2</sup>), the amount of seed is **30 lbs**.

At 0.13 acre (5,662.8 ft<sup>2</sup>), the amount of seed is

0.13 acre \* ((30 lb - 20 lb)/(0.15 acre - 0.10 acre)) = **26 lbs**.

Or

Use the Formula on the Hydraulic Application Equations Sheet.  
Find the area of coverage equation under the title Seed or Fertilizer Hydraulic Application.

The area equation is  $A \text{ (acre)} = W_{sf} / R_{sf}$

Rearrange the equation so  $W_{sf} \text{ (lb)} = (A) * (R_{sf})$

$W_{sf} \text{ (lb)} = (0.13 \text{ acre}) * (200 \text{ lb/acre}) = \mathbf{26 \text{ lbs}}$ .

This page intentionally left blank.

## Appendix D

Acronyms

Glossary of Terms

References

## ACRONYMS

USACOE	U.S. Army Corps of Engineers
AOS	Apparent Opening Size
ASTM	American Standards for Testing Materials
BOD	Biological Oxygen Demand
COD	Chemical Oxygen Demand
CWA	Clean Water Act
CWS	Clean Water Services
CZARA	Coastal Zone Act Reauthorization Amendments of 1990
CZMA	Coastal Zone Management Act of 1972
DEQ	Department of Environmental Quality
DOGAMI	Department of Geology and Mineral Industries
DSL	Department of State Lands
DOF	Department of Forestry
ECRM	Erosion Control and Revegetation Mats
EPA	Environmental Protection Agency
EPCM	Erosion and Pollution Control Manager
ESCP	Erosion Sediment Control Plan
EQC	Environmental Quality Commission
ESA	Endangered Species Act
ESCP	Erosion and Sediment Control Plan
HDPP	High Density Polyethylene Pipe
IECA	International Erosion Control Association
ISO	International Standards Organization
NMFS	National Marine Fisheries Service

**ACRONYMS**  
**(continued)**

NPDES	National Pollutant Discharge Elimination System
NRCS	Natural Resources Conservation Service
OAR	Oregon Administrative Rules
ODFW	Oregon Department of Fish and Wildlife
ODOT	Oregon Department of Transportation
ORS	Oregon Revised Statutes
PCP	Pollution Control Plan
RUSLE	Revised Universal Soil Loss Equation
SWCD	Soil and Water Conservation District
TRM	Turf Reinforcement Mats
TSS	Total Suspended Solids
TMDL	Total Maximum Daily Load
WES	Water Environment Service



## GLOSSARY OF TERMS

Adsorption	The adhesion of a substance to the substance to the surface of a solid or liquid. Heavy metals such as zinc and lead often adsorb onto particles.
Alluvial Soils	Soils developed from transported and relatively recently deposited material (alluvium) characterized by a weak modification (or none) of the original material by soil-forming processes.
Annual Storm	The highest peak storm discharge that is expected in any given year.
Apron	A pad of non-erosive material designed to prevent scour holes developing at the outlet ends of culverts, outlet pipes, grade stabilization structures, and other water control devices.
Aquifer	An underground porous, water-bearing geological formation. The term is generally restricted to materials capable of yielding an appreciable supply of water.
Base Flow	Stream discharge derived from groundwater sources as differentiated from surface runoff. Sometimes considered to include flows from regulated lakes or reservoirs.
Bedrock	The more or less solid rock in place either on or beneath the surface of the earth. It may be soft, medium or hard and have a smooth or irregular surface.
Berm	A constructed barrier of compacted earth.
Best Management Practices (BMPs)	Physical, structural and/or managerial practices employed to avoid or mitigate damage or potential damage from the contamination or pollution of surface waters or wetlands. Structural BMPs are actual physical installations rather than procedural/managerial BMPs, such as good housekeeping and employee training.
Catch Basin	A grated inlet, curb opening or combination inlet with or without a sump, which admits storm water to a sewer or sub-drain.
Channel	A natural stream or excavated ditch that conveys water.
Channel Stabilization	Protecting the sides and bed of a channel from erosion by controlling flow velocities and flow directions using jetties, drops or other structures and/or by lining the channel with a suitable liner such as vegetation, riprap, concrete or other similar material.

## GLOSSARY OF TERMS CONTINUED

Check Dam	A small dam constructed in a gully or other small watercourse to decrease flow velocity, minimize channel scour and promote sediment deposition.
Clay	(1) Soil fraction consisting of particles less than 0.002 mm in diameter. (2) A soil texture class, which is dominated by clay or at least has a larger proportion of clay than either silt or sand.
Cohesion	The capacity of a soil to resist shearing stress, exclusive of functional resistance.
Cohesive Soil	A soil that, when unconfined, has considerable strength when air-dried and significant strength when saturated.
Coir	Fiber made from coconut husks.
Compost	Organic residue or a mixture of organic residues and soil that has undergone biological decomposition until it has become relatively stable humus.
Conventional Pollutants	Contaminants (other than nutrients) such as sediment, oil, and vehicle fluids.
Contour	An imaginary line on the surface of the earth connecting points of the same elevation.
Cut	Portion of land surface or area from which earth has been removed or will be removed by excavating the depth below the original ground surface to the excavated surface.
Cut-and-Fill	Process of earth grading by excavating part of a higher area and using the excavated material for fill to raise the surface of an adjacent lower area.
Cutoff Trench	A long, narrow excavation (keyway) constructed along the center line of a dam, dike, levee or embankment and filled with relatively impervious material intended to reduce seepage of water through porous strata.
Design Highwater	The elevation of the water surface at peak flow conditions of the design flood.
Design Storm	Selected storm of a given frequency used for designing a design storm system. Hypothetical storm derived from intensity-duration-frequency curves. A prescribed hyetograph and total precipitation amount (for a specific duration recurrence frequency) used to estimate runoff in order to analyze existing drainage, design new drainage facilities or assess impacts of a proposed project on surface water flow.

## GLOSSARY OF TERMS CONTINUED

Detention	Storage and subsequent release of excess storm water runoff.
Detention Facility	An above or below ground facility, such as a pond or tank, which temporarily stores storm water runoff and releases it at a controlled rate. There is little or no infiltration of the stored storm water.
Detention Time	The theoretical time required to displace the contents of a tank or unit at a given rate of discharge (volume divided by rate of discharge).
Dewatering	The removal of water temporarily impounded in a holding basin.
Dike	An embankment to confine or control water, often built along the banks of a river or to prevent overflow of lowlands; a levee.
Discharge	Usually the rate of water flow; a volume of fluid passing a point per unit time commonly expressed as cubic feet per second, cubic meters per second, gallons per minute, or millions of gallons per day.
Dispersion, Soil	The breaking down of fine soil aggregates into individual particles, resulting in single-grain structure. Ease of dispersion influences the erodibility of soils. Generally speaking, the more easily dispersed the soil, the more erodible it is.
Diversion	A channel with a supporting ridge on the lower side constructed at the top, across, or at the bottom of a slope for the purpose of controlling surface runoff.
Diversion Dike	A barrier built to divert surface runoff.
Drain	A buried slotted or perforated pipe or other conduit (subsurface drain) or a ditch (open drain) for carrying off surplus groundwater or surface water.
Drainage	The removal of excess surface water or groundwater from land by means of ditches or subsurface drains.
Drainageway	A natural or artificial depression that carries surface water to a larger watercourse or outlet such as a river, lake, or bay.
Drop Inlet	Overall structure in which the water drops through a vertical riser connected to a discharge conduit or storm sewer.
Earth Dam	Dam constructed of compacted suitable soil materials.
Elongation	The increase in length produced in the gage length produced by a tensile load.
Embankment	A man-made deposit of soil, rock, or other material often used to form an impoundment.

## GLOSSARY OF TERMS CONTINUED

Emergency Spillway	Usually a vegetated earth channel used to safely convey flood discharges around an impoundment structure.
Energy Dissipater	A device used to reduce the energy of flowing water to prevent erosion.
Environment	The sum total of all the external conditions that may act upon a living organism or community to influence its development or existence.
Erodibility	Susceptibility to erosion.
Erosion	<p>The wearing away of the land surface by water, wind, ice, gravity, or other geological agents. The following terms are used to describe different types of water erosion:</p> <ul style="list-style-type: none"><li>• Accelerated erosion – Erosion much more rapid than normal or geological erosion, primarily as a result of the activities of man.</li><li>• Channel erosion – The erosion process whereby the volume and velocity of flow wears away the bed and/or banks of a well-defined channel.</li><li>• Gully erosion – The erosion process whereby runoff water accumulates in narrow channels and, over relatively short periods, removes the soil to considerable depths, ranging from 1 to 2 feet to as much as 75 to 100 feet.</li><li>• Rill erosion – An erosion process in which numerous small channels only several inches deep are formed; occurs mainly on recently disturbed and exposed soils. See Rill.</li><li>• Splash erosion – The spattering of small soil particles caused by the impact of raindrops on wet soils. The loosened and spattered particles may or may not be subsequently removed by surface runoff.</li><li>• Sheet erosion – The gradual removal of a fairly uniform layer of soil from the land surface by runoff water.</li></ul>
Erosion and Sediment Control	Any temporary or permanent measures taken to reduce erosion, control siltation and sedimentation, and ensure that sediment-laden water does not leave a site.
Erosion and Sediment Control Plan (ESCP)	Plans, specification and BMP details intended to prevent and control erosion and sediment related to the project construction activities.
Evapotranspiration	The combined loss of water from an area by evaporation from the soil surface and by transpiration of plants.
Filter Fabric	A woven or non-woven, water permeable material generally made of synthetic products such as polypropylene and used in erosion and sediment control applications to trap sediment or prevent the movement of fine soil particles. Often used instead of a filter blanket.
Flood Peak	The highest stage or greatest discharge attained by a flood event. Thus, peak states or peak discharge.

## GLOSSARY OF TERMS CONTINUED

Floodplain	The lowland that borders a stream and is subject to flooding when the stream overflows its banks.
Flood Stage	The stage at which overflow of the natural banks of a stream begins.
Floodway	A channel, either natural, excavated, or bounded by dikes and levees, used to carry flood flows.
Freeboard	Vertical clearance between the normal operating level and the top side of an open conduit or channel. Vertical distance between the design water surface elevation and the elevation of the barrier retaining the water.
Frequency of Storm (Design storm frequency)	The anticipated period in years that will elapse before another storm of equal intensity and/or total volume will recur: a 10-year storm can be expected to occur on the average once every 10 years.
Gabion	A wire mesh cage, usually rectangular, filled with rock and used to protect channel banks and other sloping areas from erosion.
Gauge	Device for measuring precipitation, water level, discharge, velocity, pressure, temperature, etc., e.g., a rain gauge. A measure of the thickness of metal, e.g., diameter of wire or wall thickness of steel pipe.
Geotextile	Any permeable textile used with foundation, rock, earth or any other geotechnical engineering-related material as an integral part of a human-made project, structure or system.
Grade	(1) the slope of a road, a channel, or natural ground. (2) The finished surface of canal bed, roadbed, top of embankment, or bottom of excavation; any surface prepared to a design elevation for the support of construction such as paving or the laying of a conduit. (3) To finish the surface of a canal bed, roadbed, top of embankment, or bottom of excavation, or other land area to a smooth, even condition.
Grade Stabilization Structure	A structure for the purpose of stabilizing the grade of a gully or other watercourse, thereby preventing further head-cutting or lowering of the channel bottom.
Gradient	Change of elevation, velocity, pressure, or other characteristics per unit length; slope.
Grading	The cutting and/or filling of the land surface to a desired slope or elevation.
Grass	A member of the botanical family Gramineae, characterized by blade-like leaves that originate as a sheath wrapped around the stem.
Grassed Waterway	A natural or constructed waterway, usually broad and shallow, covered with erosion-resistant grasses and used to safely conduct surface water from an area.

## GLOSSARY OF TERMS CONTINUED

Ground Cover	(Horticulture) Low-growing, spreading plants useful for low maintenance landscape areas.
Habitat	The environment in which the life needs of a plant or animal are supplied.
Harmful Pollutant	A substance which has adverse effects on an organism. Adverse effects include immediate death, chronic poisoning, impaired reproduction and other conditions.
Head Loss	Energy loss due to friction, eddies, changes in velocity, elevation or direction of flow.
Headwater	The source of a stream. The water upstream from a structure or point a stream.
Heavy Metals	Metals having a high specific gravity, present in municipal and industrial wastes, and pose long-term environmental hazards. Such metals include cadmium, chromium, cobalt, copper, lead, mercury, nickel and zinc.
Hydrologic Cycle	The circuit of water movement from the atmosphere to the earth and back to the atmosphere through various stages or processes such as precipitation, interception, runoff, infiltration, percolation, storage, evaporation, and transpiration.
Hydrology	The science of the behavior of water in the atmosphere, on the surface of the earth, and underground.
Impervious	A surface, which water, can not easily penetrate. Can include graveled surface as well as paved surfaces.
Infiltration	The downward movement of water from the surface to the subsoil.
Invert	The inside bottom of a culvert or other conduit.
Land Capability	The suitability of land for use. Land capability classification involves consideration of: 1) the risks of land damage from erosion and other causes and 2) the difficulties in land use owing to physical land characteristics, including climate.
Land Use Controls	Methods for regulating the uses to which a given land area may be put, including such things as zoning, subdivision regulation, and floodplain regulation.
Loam	A soil textural classification in which the proportions of sand, silt and clay are well balanced. Loams have the best properties for cultivation of plants.
Mean Velocity	The average velocity of a stream flowing in a channel or conduit at a given cross-section or in a given reach. It is equal to the discharge divided by the cross-section area of the reach.

## GLOSSARY OF TERMS CONTINUED

Mitigation	Means, in the following order of importance: <ol style="list-style-type: none"><li>1. Avoiding the impact altogether by not taking a certain action or part of an action.</li><li>2. Minimizing impacts by limiting the degree or magnitude of the action and its implementation, by using appropriate technology, or by taking affirmative steps to avoid or reduce impacts.</li><li>3. Rectifying the impact by repairing, rehabilitating or restoring the affected environment.</li><li>4. Reducing or eliminating the impact over time by preservation and maintenance operations during the life of the action and</li><li>5. Compensation for the impact by replacing, enhancing, or providing substitute resources or environments.</li></ol>
Mulch	A natural or artificial layer of plant residue or other materials covering the land surface which conserves moisture, holds soil in place, aids in establishing plant cover, and minimizes temperature fluctuations.
National Pollutant Discharge Elimination System (NPDES)	The part of the Federal Clean Water Act, which requires permits (NPDES permits) for point and nonpoint source discharges.
Natural Drainage	The flow patterns of storm water runoff over the land in its pre-development state.
Nonpoint Source Pollution	Pollution that enters a water body from diffuse origins on the watershed and does not result from discernible, confined, or discrete conveyances.
Normal Depth	Depth of flow in an open conduit during uniform flow for the given conditions.
Nutrients	Essential chemicals for plant and animal growth. Excessive amounts can lead to water quality degradation and algae blooms. Some nutrients are toxic at high concentrations.
Open Drain	Natural watercourse or constructed open channel that conveys drainage water.
Outfall	The point, location, or structure where wastewater or drainage discharge from a sewer to a receiving body of water.
Outlet	Point of water disposal from a stream, river, lake tidewater, or artificial drain.
Outlet Channel	A waterway constructed or altered primarily to carry water from man made structures, such as smaller channels, tiles, lines, and diversions.
Peak Discharge	The maximum, instantaneous flow rate during a storm, usually in reference to a specific design storm event.

## GLOSSARY OF TERMS CONTINUED

Permeability	A generic term for the ability of a material to conduct a fluid.
Permeable Soils	Soil materials with filtration rate of 10 minutes per inch or better. Such soils allow infiltration and reduce or eliminate surface and storm water runoff. Classified as SCS (Soil Conservation Services) Type A.
Permeability Rate	<p>The rate at which water will move through a saturated soil. Permeability rates are classified as follows:</p> <ul style="list-style-type: none"><li>• Very slow – Less than 0.06 inches per hour.</li><li>• Slow – 0.06 to 0.20 inches per hour.</li><li>• Moderately slow – 0.20 to 0.63 inches per hour.</li><li>• Moderate – 0.63 to 2.0 inches per hour.</li><li>• Rapid – 6.3 to 20.0 inches per hour.</li><li>• Very rapid – More than 20.0 inches per hour.</li></ul>
Permittivity	For a geotextile, the volumetric flow rate of water per unit cross-section area, per unit head, under laminar flow conditions, in the normal direction through the fabric.
Point Source	Any discernible, confined and discrete conveyance, including but not limited to, any pipe ditch, channel, tunnel, conduit, well, discrete fissure, container, roller stock, concentrated animal feeding operation, or vessel or other floating craft, from which pollutants are or may be discharged.
Point Source Pollutants	Pollution, which enters a water body resulting from discernible confined or discrete conveyances.
Pollution Control Plan	Consists of Pollution Control Plan form, narrative, site map and details describing measures to prevent pollution related to contractor activities. Special Provision 00170.30 © spells out the Contractor's responsibilities related to Pollution Control.
Pervious	Allowing movement of water.
Porosity	The volume of pore space in soil or rock.
pH	A numerical measure of hydrogen ion activity. The neutral point is pH 7.0. All pH values below 7.0 are acid and all above 7.0 are alkaline.
Rainfall Intensity	The rate at which rain is falling at any given instant, usually expressed in inches per hour.
Rational Method	A means of computing storm drainage flow rates, Q, by use of the formula $Q=CIA$ , where C is coefficient describing the physical drainage area, I is the rainfall intensity and A is the area.
Receiving Stream	The body of water into which runoff or effluent is discharged.



## GLOSSARY OF TERMS CONTINUED

Retention	The process of collecting and holding surface and storm water runoff with no surface overflow.
Retention/Detention Facility	A type of drainage facility designed either to hold water for a considerable length of time and then release it by evaporation, plant transpiration, and/or infiltration into the ground, or to hold surface and storm water runoff for a short period of time and then release it to the surface and storm water management system.
Retention Structure	A natural or artificial basin that functions similar to a detention structure except that it maintains a permanent water supply.
Riparian	Pertaining to banks of streams, wetlands, lakes or tide waters.
Riser	The inlet portions of a drop inlet spillway that extends vertically from the pipe conduit barrel to the water surface.
Runoff	That portion of precipitation that flows from drainage area on the land surface, in open channels or in storm water conveyance systems.
Salmonid	A member of the fish family <i>salmonidae</i> . Includes Chinook, coho, chum, sockeye and pink salmon, cutthroat, steelhead, rainbow, Dolly varden, brook, kokanee and whitefish.
Sand	(1) Soil particles between 0.05 and 2.0 mm in diameter. (2) a soil textural class inclusive of all soils which are at least 70% sand and 15% or less clay.
Saturation	In soils, the point at which a soil or an aquifer will no longer absorb any amount of water without losing an equal amount.
Scour	The clearing and digging action of flowing water, especially the downward erosion caused by stream water in sweeping away mud and silt from the streambed and outside bank of a curved channel.
Sediment	Fragmented material originated from weathering and erosion of rocks and unconsolidated deposits. The material is transported by, suspended in, or deposited by water.
Sedimentation	Deposition or formation of sediment.
Sediment Delivery Ratio	The fraction of the soil eroded from upland sources that actually reaches a stream channel or storage reservoir.
Sediment Discharge	The quantity of sediment, measured in dry weight or by volume, transported through a stream cross-section in a given time. Sediment discharge consists of both suspended load and bedload.
Seedbed	The soil prepared by natural or artificial means to promote the germination of seed and the growth of seedlings.
Seedling	A young plant grown from seed.

## GLOSSARY OF TERMS CONTINUED

Sheet Erosion	Relatively uniform removal of soil from an area without the development of conspicuous water channels.
Sheet Flow	Relatively uniform flow over a plan surface without concentration of water into conspicuous channels.
Shoot	The above-ground portion of a plant.
Silt	(1) Soil fraction consisting of particles between 0.002 and 0.05 mm in diameter. (2) A soil textural class indicating more than 80% silt.
Siltation	Process by which a river, lake or other water body becomes clogged with sediment. Siltation can clog gravel beds and prevent successful salmon spawning.
Slope	Degree of deviation of a surface from the horizontal; measured as a numerical ration or percent. Expressed as a ratio, the first number is the horizontal distance (run) and the second is the vertical distance (rise), e.g., 2:1. Slope can also be expressed as the rise over the run. For instance, a 2:1 slope is a 50 percent slope.
Soil	The unconsolidated mineral and organic material on the immediate surface of the earth that serves as a natural medium for the growth of land plants.
Soil Horizon	A horizontal layer of soil that, through processes of soil formation, has developed characteristics distinct from the layers above and below.
Soil Profile	A vertical section of the soil from the surface through all horizons.
Soil Stabilization	Use of rock-lining, vegetation or other methods to prevent soil movement when loads are applied to the soil.
Soil Structure	The relation of particles or groups of particles which impart to the whole soil a characteristic manner of breaking; some types are crumb structure, block structure, platy structure, and columnar structure.
Soil Texture	The physical structure or character of soil determined by the relative proportions of the soil separates (sand, silt and clay) of which it is composed.
Spillway	A passage such as a paved apron or channel for surplus water over or around or through a dam or similar structure. An open or closed channel, or both, sued to convey excess water from a reservoir. It may contain gates, whether manually or automatically controlled, to regulate the discharge of excess water.
Storm Frequency	The statistical time interval between major storms of predetermined intensity and runoff volumes for which storm sewers and other structures are designed and constructed to handle hydraulically without surcharge or back-flood.

## GLOSSARY OF TERMS CONTINUED

Storm Sewer	A sewer that carries storm water, surface drainage, street wash and other wash waters, but excludes sewage and industrial wastes. Also called a storm drain.
Storm Water	That portion of precipitation that does not percolate into the ground or evaporate, but flows via overland flow, interflow, channels or pipes into a defined surface water channel, or a constructed infiltration facility.
Storm Water Facility	A constructed component of a storm water drainage system, designed or constructed to perform particular function, or multiple functions. Storm water facilities include pipes, swales, ditches, culverts, street gutters, detention basins, retention basins, constructed wetlands and other.
Streambanks	The usual boundaries, not the flood boundaries, of a stream channel. Right and left banks are named facing downstream.
Subsoil	The B horizons of soils with distinct profiles. In soils with weak profile development, the subsoil can be defined as the soil below which roots do not normally grow.
Subsurface Drain	A pervious backfilled trench usually containing stone and perforated pipe for intercepting groundwater or seepage.
Surface Runoff	Precipitation that falls onto the surfaces of roofs, streets, the ground, etc., and is not absorbed or retained by that surface, but collects and runs off.
Suspended Solids	Organic or inorganic particles suspended in and carried by water, sand, mud, clay as well as solids.
Swale	An elongated depression in the land surface that is at least seasonally wet, is usually heavily vegetated, and is normally without flowing water. Swales conduct storm water into primary drainage channels and may provide some groundwater recharge.
Time of Concentration	The time period necessary for surface water runoff to reach the outlet of a sub-basin from the hydraulically most remote point in the tributary drainage area.
Toe of Slope	The base or bottom of a slope at the point where the ground surface abruptly changes to a significantly flatter grade.
Topography	General term to include characteristics of the ground surface such as plains, hills, mountains, degree of relief, steepness of slopes, and other physiographic features.
Topsoil	The dark-colored surface layer of A horizon of a soil. When present it ranges in depth from a fraction of an inch to 2 or 3 feet; equivalent to the plow layer of cultivated soils. Commonly used to refer to the surface soil layer(s), enriched in organic matter and having textural and structural characteristics favorable for plant growth.

## GLOSSARY OF TERMS CONTINUED

Total Suspended Solids (TSS)	<p>The entire amount of organic and inorganic particles dispersed in water.</p> <p>TSS are the larger particles in the water which are more easily removed by sedimentation than smaller particles which cause turbidity.</p>
Toxicity	<p>The characteristics of being poisonous or harmful to plant animal life; the relative degree or severity of the characteristic.</p>
Trash Rack	<p>A structural device used to prevent debris from entering a pipe spillway or other hydraulic structure.</p>
Turbidity	<p>Is caused by silt and clay particles, particles smaller than 0.02 mm, suspended in water. Measurement of turbidity can be done by turbidimeter which measures light-beam scatter caused by small suspended particles and converts it to NTU (national turbidity units).</p>
Turf	<p>Surface soil supporting a dense growth of grass and associated root mat.</p>
Vegetative Stabilization	<p>Protection of erodible or sediment-producing areas with:</p> <ul style="list-style-type: none"><li>• Permanent seeding, producing long-term vegetative cover,</li><li>• Short-term seeding, producing temporary vegetative cover, or</li><li>• Sodding, producing areas covered with a turf of perennial sod-forming grass.</li></ul>
Watercourse	<p>A definite channel with bed and banks within which concentrated water flows, either continuously or intermittently.</p>
Water Quality	<p>A term used to describe the chemical, physical, and biological characteristics of water, usually in respect to its suitability for a particular purpose.</p>
Water Resources	<p>The supply of groundwater and surface water in a given area.</p>
Watershed Area	<p>All land and water within the confines of a drainage divide.</p>
Water Table	<p>The free surface of the groundwater. That surface subject to atmospheric pressure under the ground, generally rising and falling with the season, or from other conditions such as water withdrawal.</p>
Weir	<p>Device for measure or regulating the flow of water.</p>
Wet Pond	<p>A facility treating storm water by utilizing a permanent pool of water to remove conventional pollutants from runoff. Treatment mechanisms include sedimentation, biological uptake and plant filtration.</p>
Wet Season	<p>October to May.</p>

## REFERENCES

1. Arizona Department of Transportation, ADOT Erosion and Pollution Control Manual, June 1995.
2. Association of Bay Area Governments, Manual of Standards for Erosion and Sediment Control Measures, 1995.
3. Beak Consultants, Erosion Control Manual for ODOT Projects within the Tualatin River Basin, March 1993.
4. California Regional Water Quality Control Board – San Francisco Bay, Erosion and Sediment Control Field Manual.
5. Reconstruction of Existing Bridges, 1998.
6. Camp, Dresser & McKee, California Stormwater Best Management Practice Handbook, March 1993.
7. Charles A. White and A.L. Franks, Demonstration of Erosion and Sediment Control Technology Lake Tahoe Region of California, U.S. Environmental Protection Agency Publication EPA – 600/2 – 208, 1978.
8. Colorado Department of Transportation, Erosion Control and Stormwater Quality Guide Draft, November 1992.
9. FHWA, Hydraulic Design of Energy Dissipaters for Culverts and Channels, Hydraulic Engineering Curricular No. 14, September 1983.
10. Goldman, S.J., Jackson, K., Bursztynsky, T.A., Erosion and Sediment Control Handbook, McGraw-Hill, Inc., 1986.
11. King County, Washington Surface Design Manual, Department of Public Works, 1994.
12. Koerner, Robert M., Designing with Geosynthetics, Prentice-Hall, 1986.
13. McCullah, J., Salix Applied Earthcare, Erosion Draw 2.0, Erosion and Sediment Control Manual for Computer-Aided Drafting, 1994.
14. North Carolina Sediment Control Commission, North Carolina Department of Natural Resources, and Community Development, and the North Carolina Agricultural Extension Service, Erosion and Sediment Control Planning and Design Manual, 1988.
15. North Carolina Sediment Control Commission, North Carolina Department of Natural Resources, and Community Development, and the North Carolina Agricultural Extension Service, Erosion and Sediment Control Field Manual, 1988.
16. ODOT and Woodward-Clyde Consultants, Implementation Plan for the Oregon Department of Transportation NPDES permit Program (within the Portland Urban Services Area), June 1994.
17. ODOT Highway Division, Hydraulic Manual., 1990.
18. Oregon City Ordinance 95 – Amendment to Title 17, Chapter 47 ( Erosion Control )
19. San Francisco Estuary Project, Comprehensive Conservation and Management Plan, 1994.

## REFERENCES CONTINUED

20. Storm Water Quality Task Force, California Storm Water Best Management Practice Handbooks, Construction Activity Volume 3, 1993.
21. Tisdale, S.L., Werner, N.L., Beaton, J.D., Havlin, J.L., Soil Fertility and Fertilizers Fifth Edition, Macmillan Publishing Company, New York 1993.
22. Unified Sewerage Agency and City of Portland, Bureau of Environmental Services, Erosion Prevention and Sediment Control Plans, Technical Guidance Handbook, February, 1994.
23. Unified Sewerage Agency, Design and Construction Standards for Sanitary Sewer and Surface Water Management, 2000.
24. University of Madison Wisconsin – Madison, College of Engineering, Department of Engineering Professional Development, Applied Biogeotechnology , Sensible Solutions for our Build Environment, 1998.
25. USDOT, Best Management Practices and Erosion and Erosion and Sediment Control, FHWA-FLP-94-0005, June 1995.
26. Virginia Soil and Water Commission, Virginia Erosion and Sediment Control Handbook, Edition 2, Richmond, Virginia, 1980.
27. Washington State Department of Ecology, Storm Water Management Manual for the Puget Sound Basin, The Technical Manual, February 1992.
28. Washington State Department of Transportation, Highway Runoff Manual, February 1995.
29. Wolmon, and A.P. Schick, Water Resources Research, 3:451-464, 1967.
30. Washington State Department of Ecology, Stormwater Management Manual for the Puget Sound Basin, 1992.
31. Aldrich, Bob; Kramer, Chin & Mayo, Inc., Seattle, WA, personal communication.
32. Hopkins, Keith, Hobbs and Hopkins, Ltd., Portland, OR, personal communication.
33. King County, Washington, Surface Water Management Division, Department of Public Works. January 1990. “ Surface Water Design Manual”.
34. Oregon Administrative Rules. 1989. OAR 340-41-455.
35. Oregon Department of Transportation, State Highway Division. 1984. “Standard Specifications for Highway Construction”.
36. Oregon Department of Transportation, State Highway Division. “Hydraulics Manual”.
37. ODOT Erosion and Sediment Control Manual, 2000.
38. U.S. Department of Agriculture, Science & Education Administration. December 1978. Predicting Rainfall Erosion Losses, A Guide to Conservation Planning. Agriculture Handbook No. 537
39. USDA Soil Conservation Service and Washington County Soil and Water Conservation District. April 1981. “Urban Conservation Guide for Washington County, Oregon”, parts A and B.